

**L**

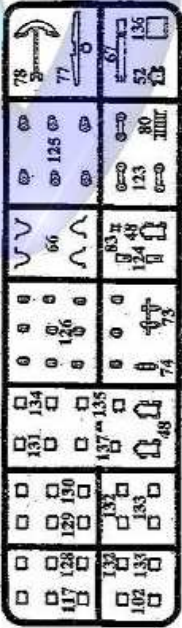

**H2X**

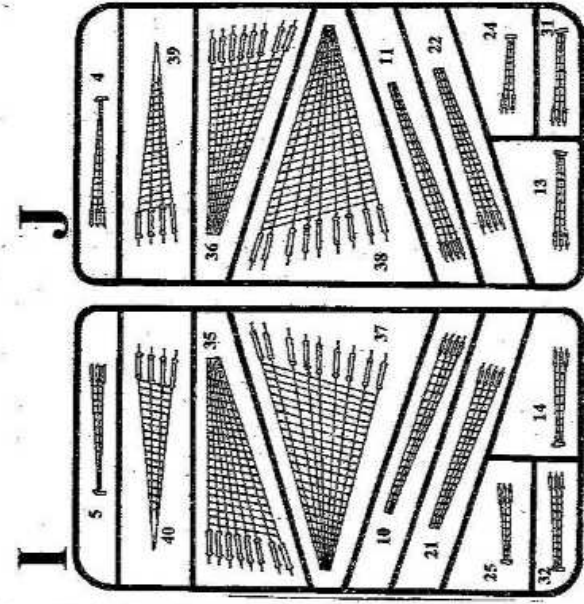
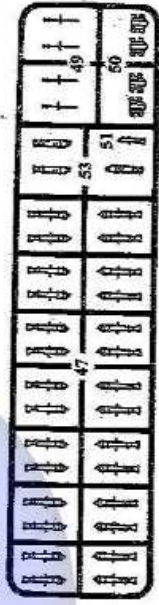

**K**

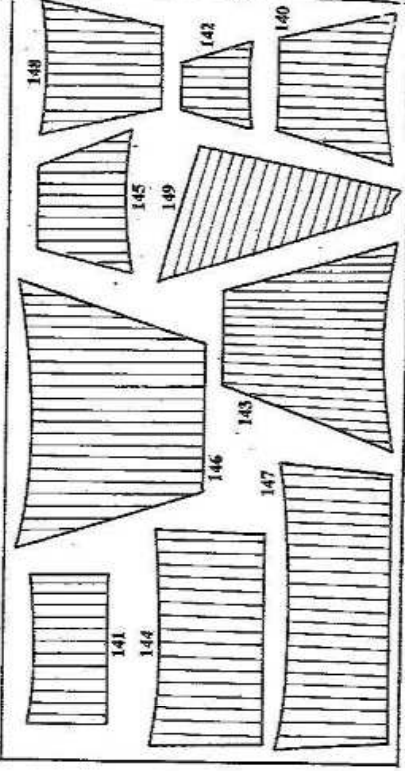

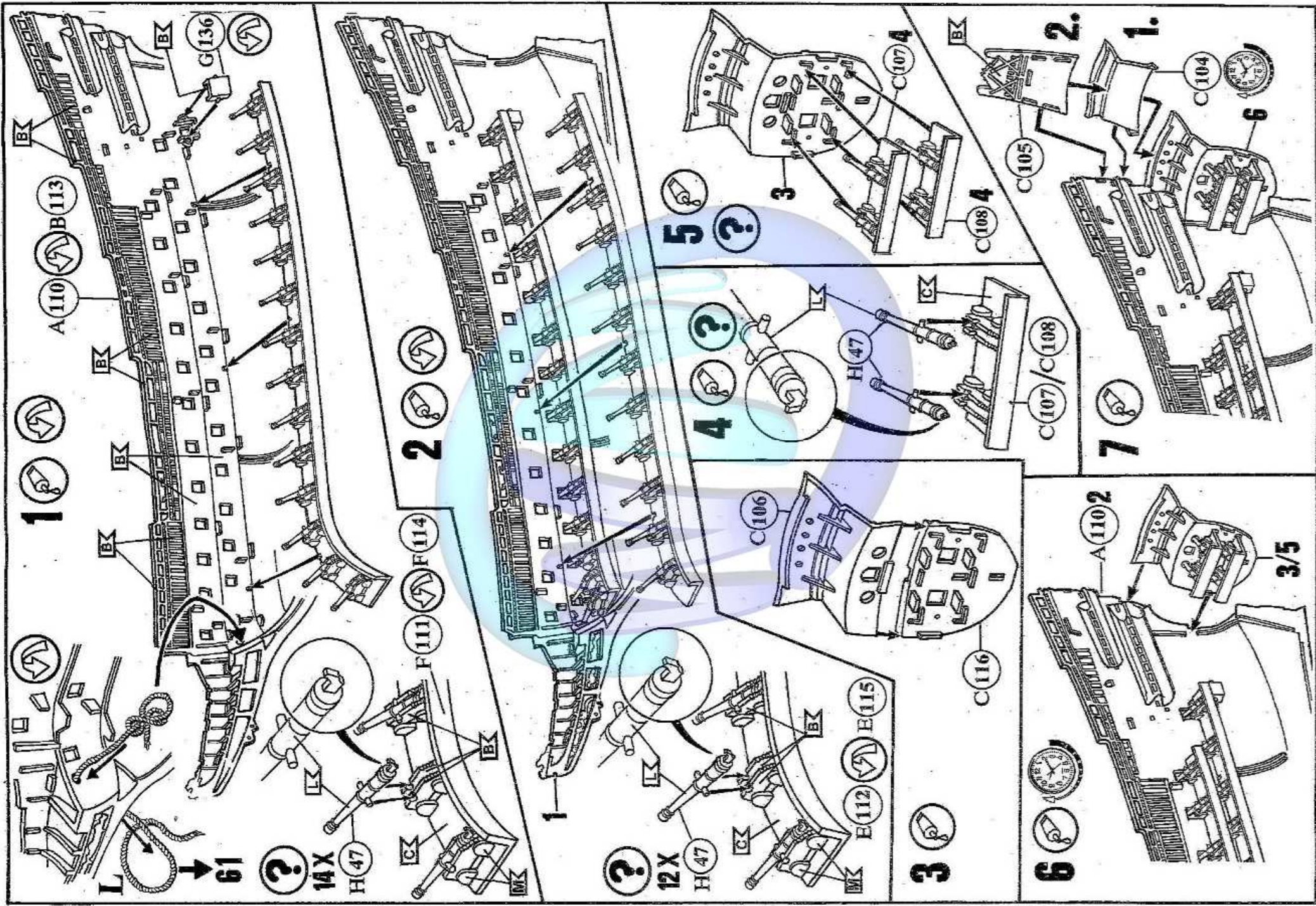

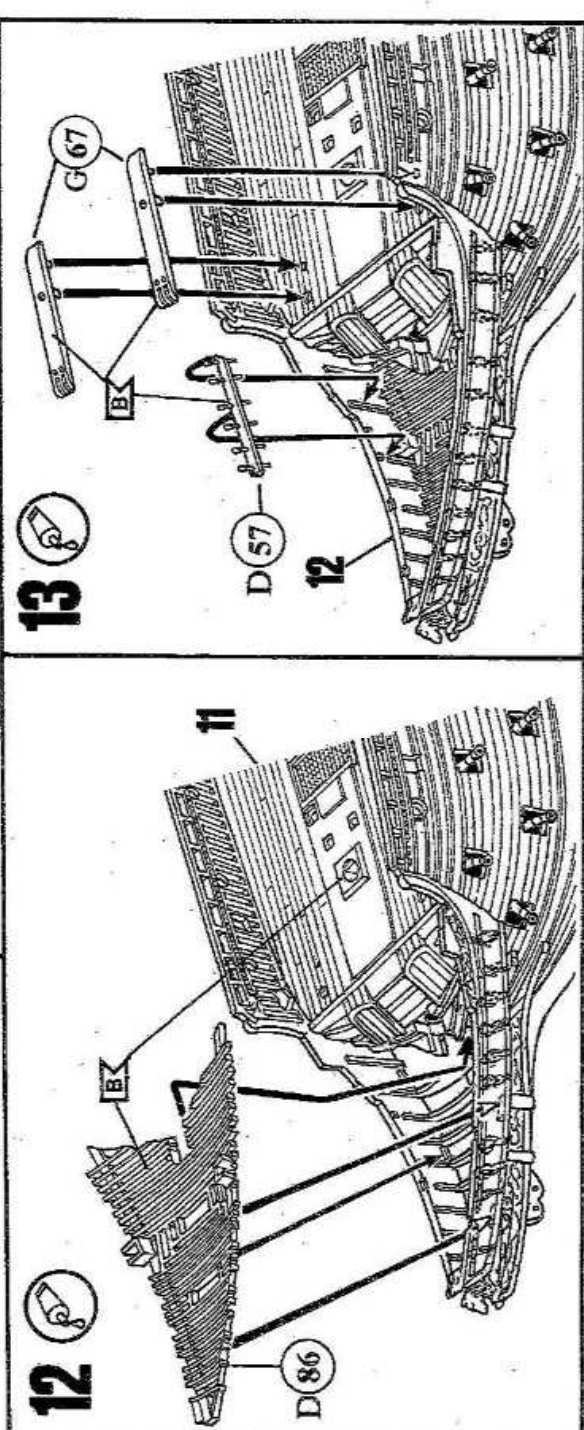
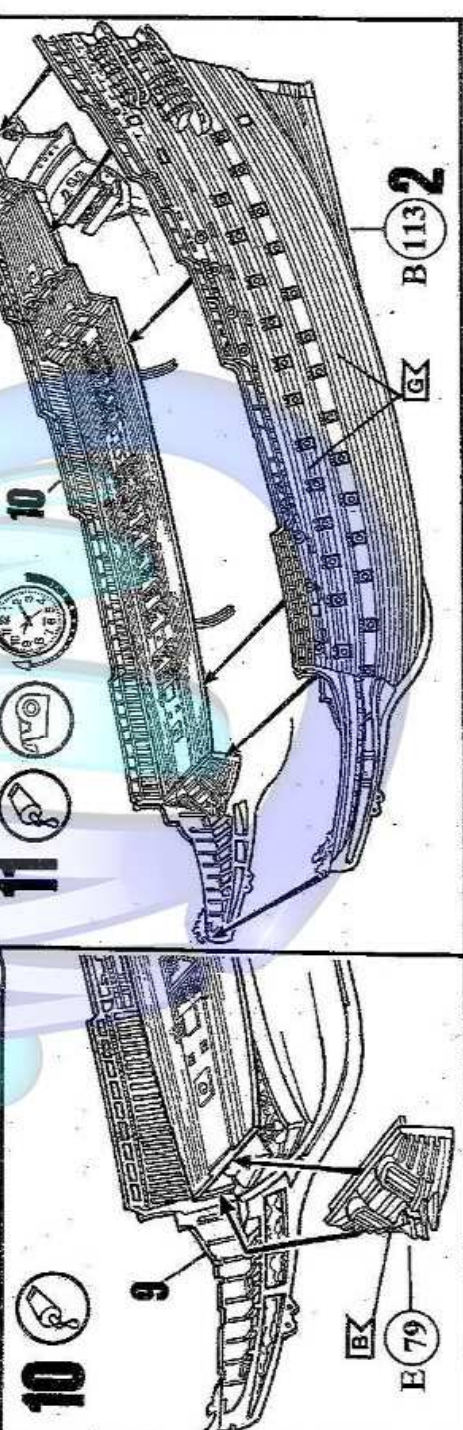
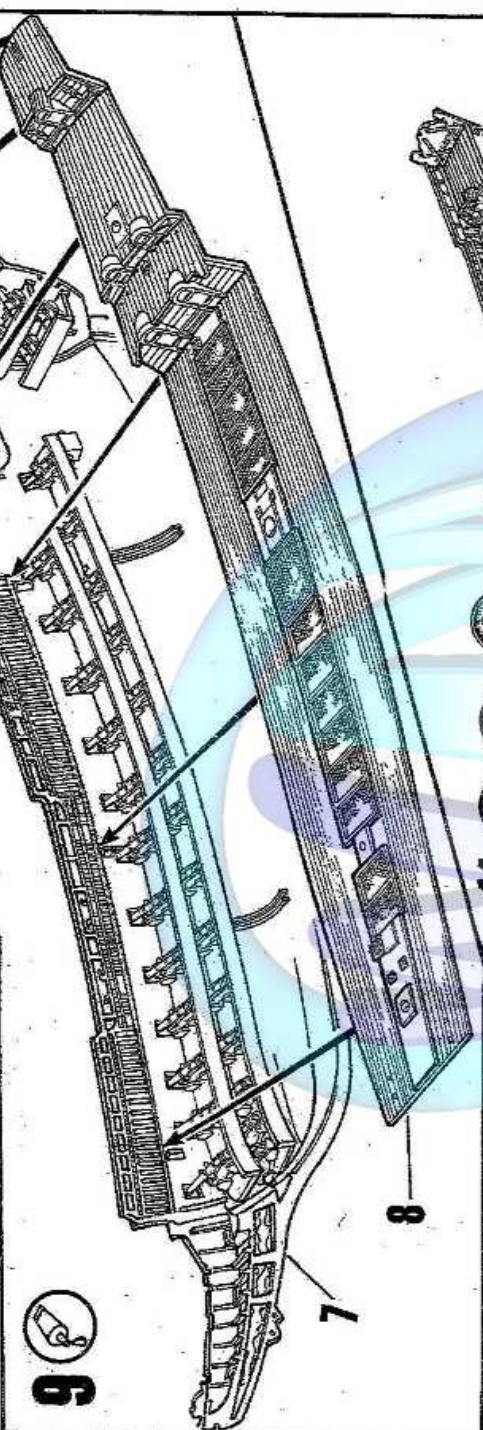
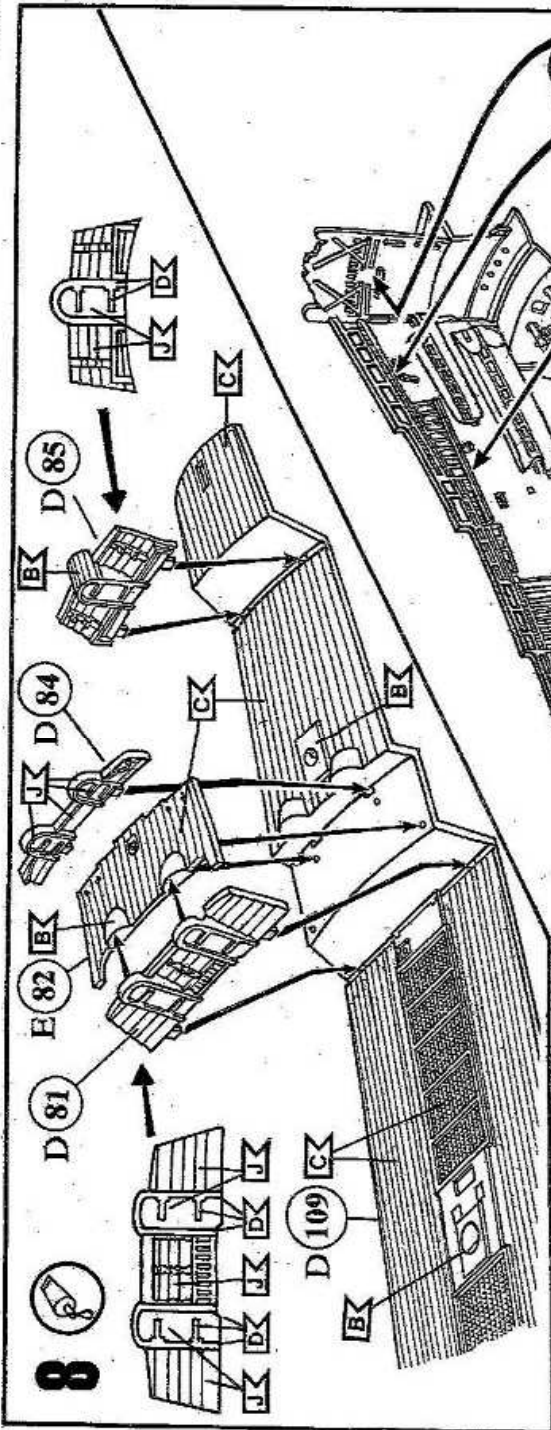

14

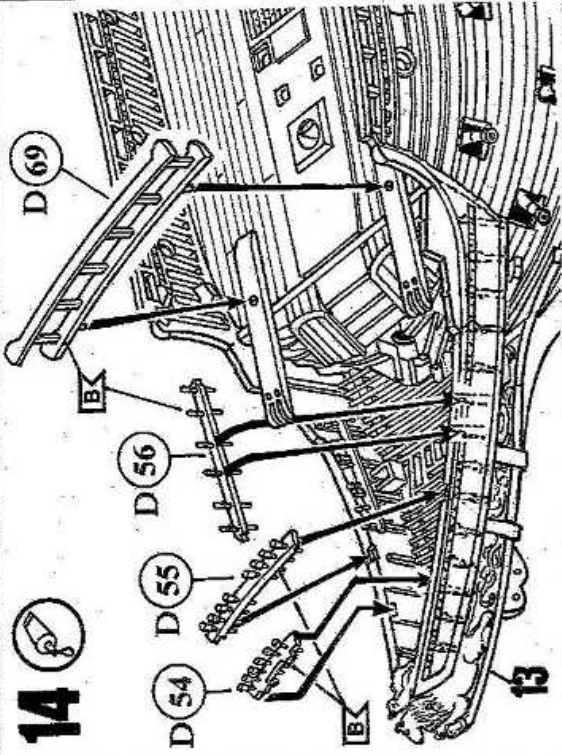

15

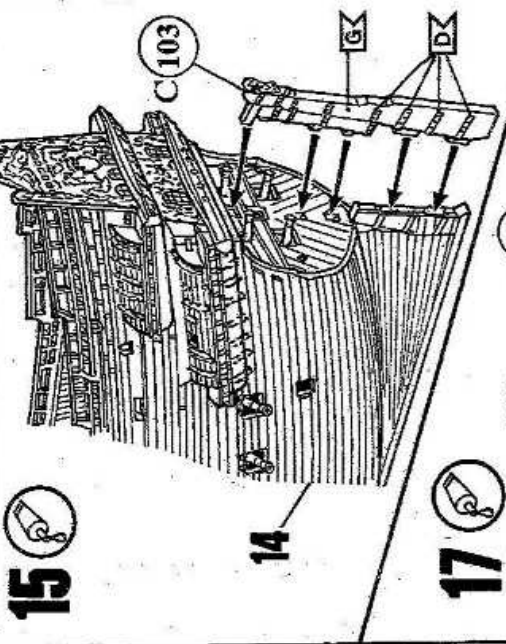

17

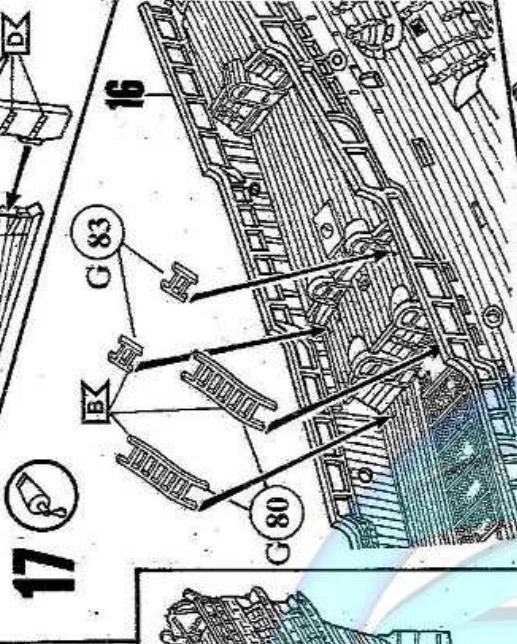

16

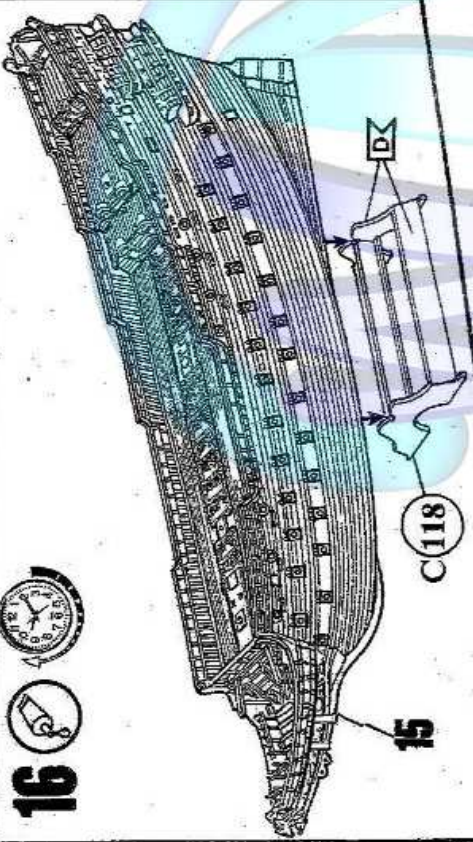

18

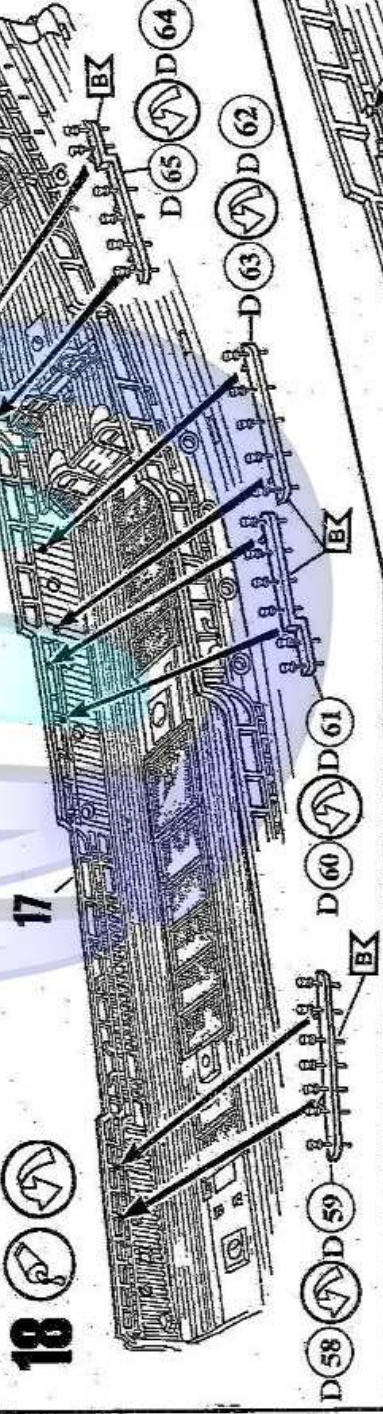

19

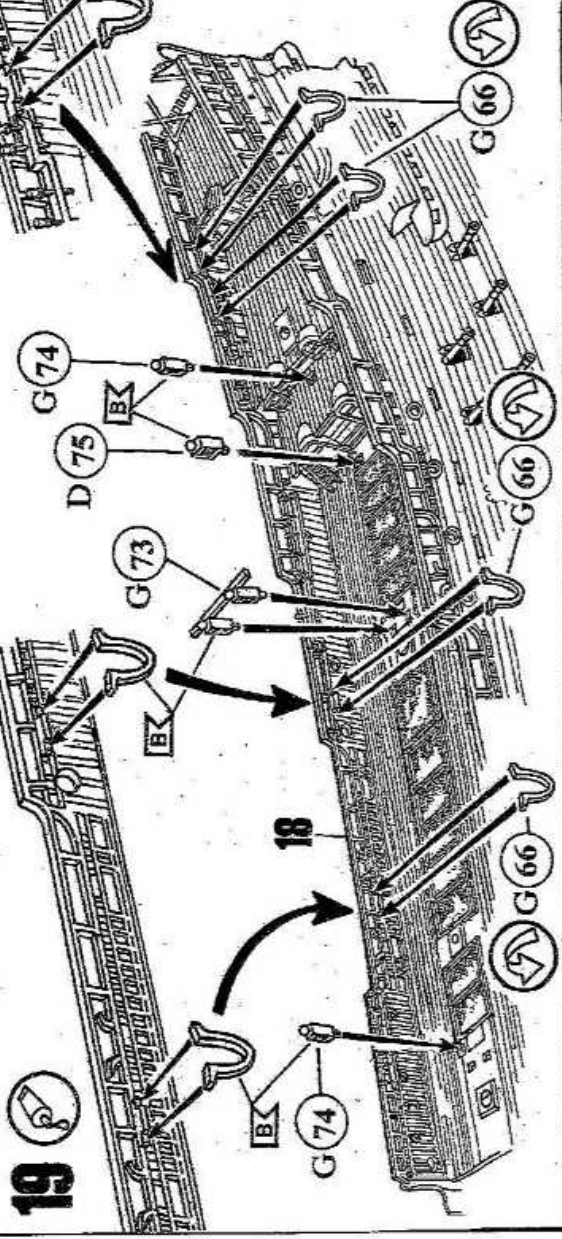

20

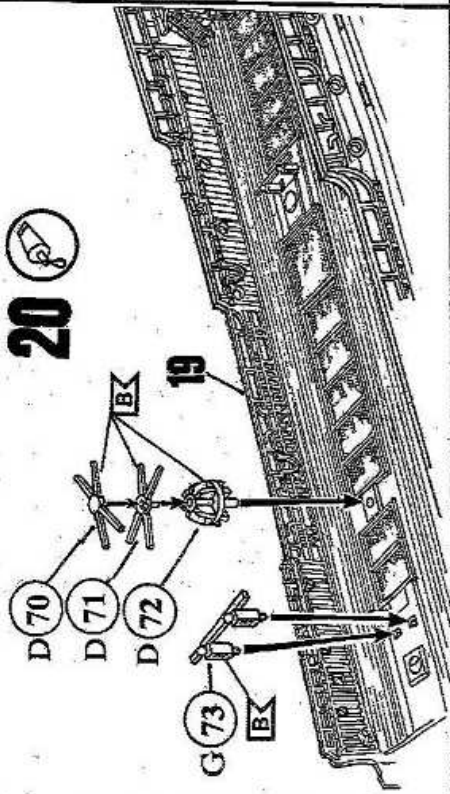

21



2X

22



6X

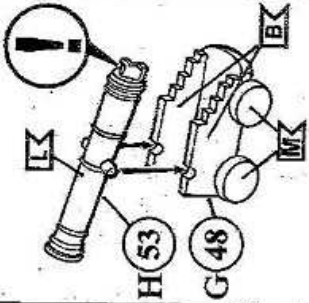
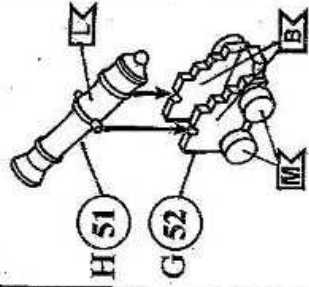

23



8X

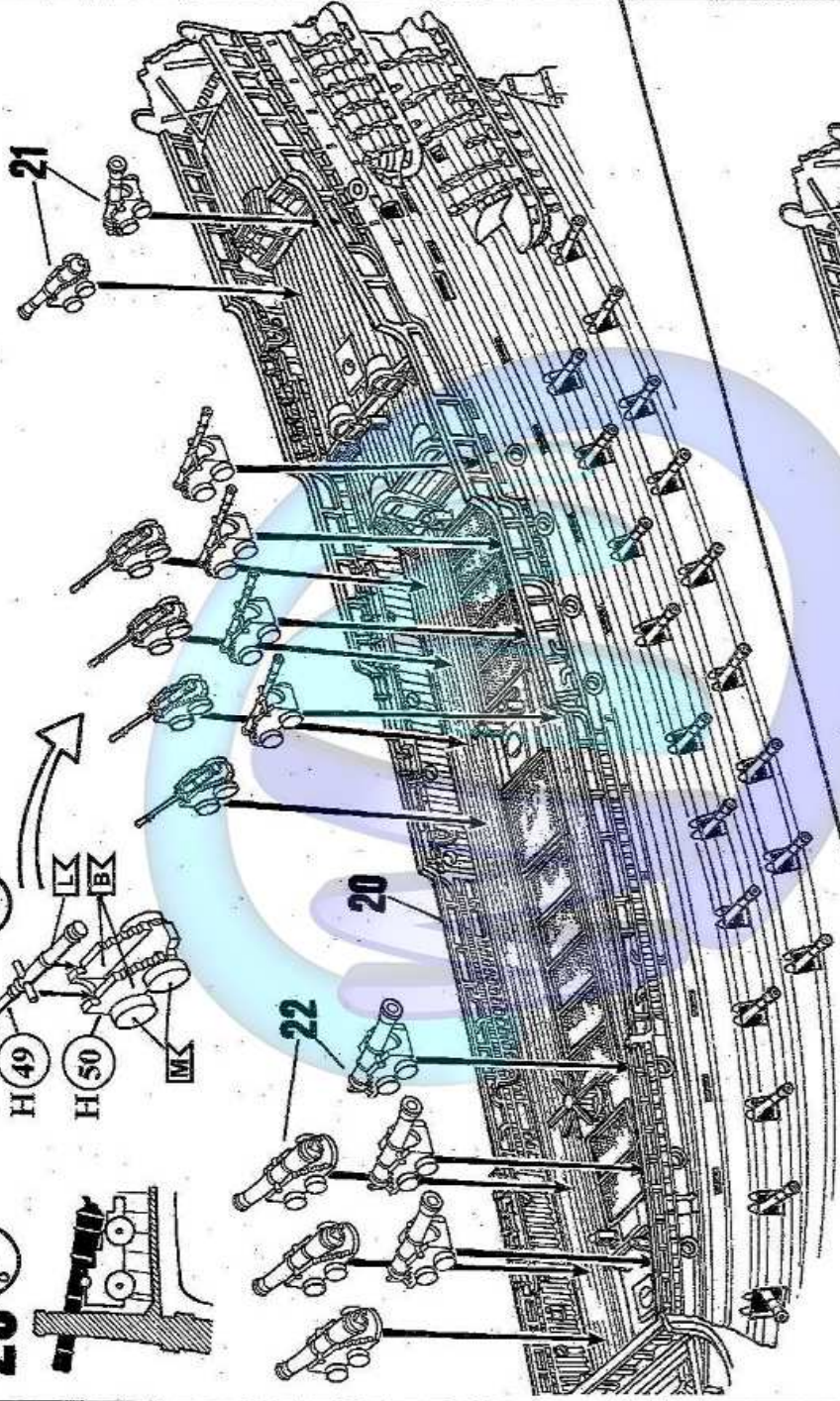
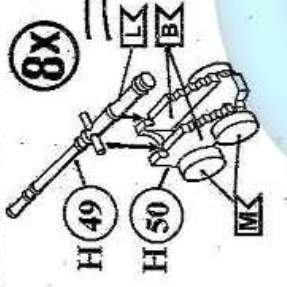

24

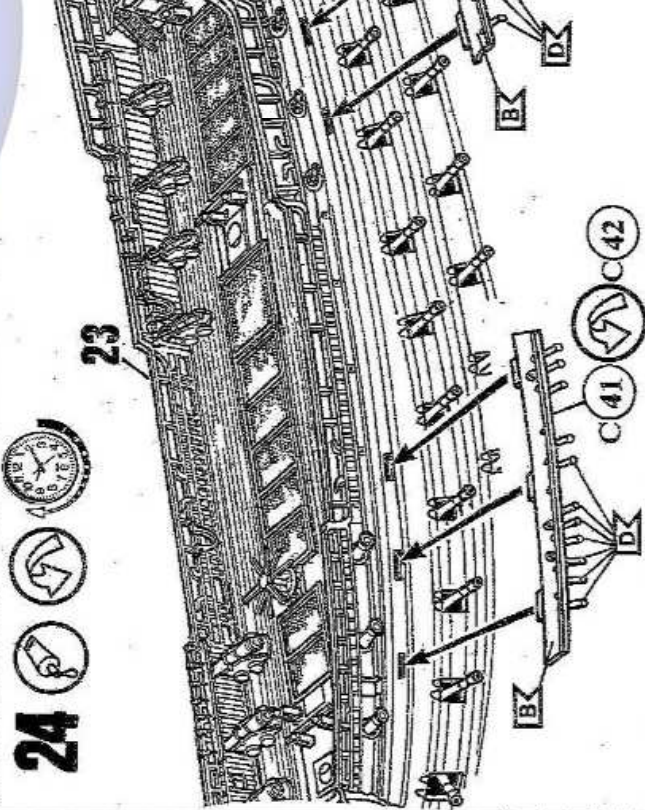

25



27

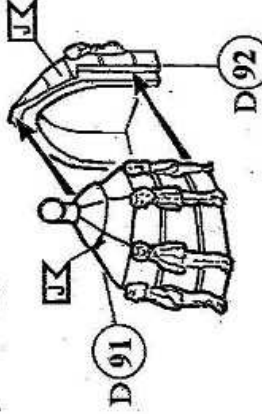
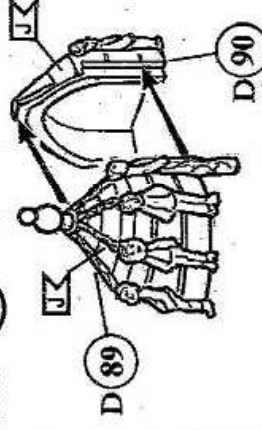
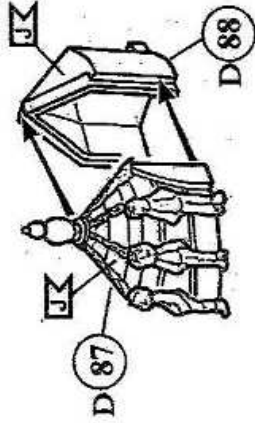

28



30

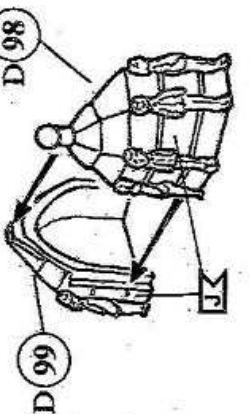
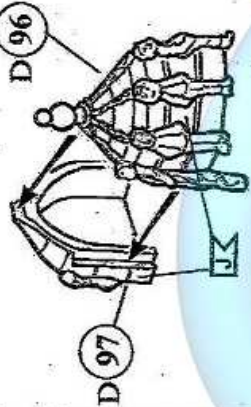
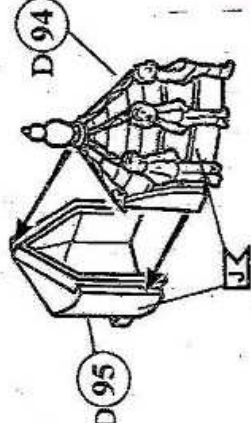

31



32

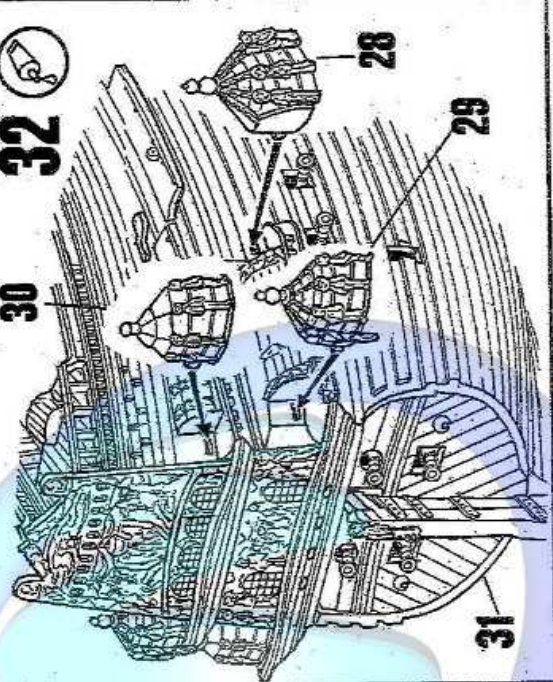
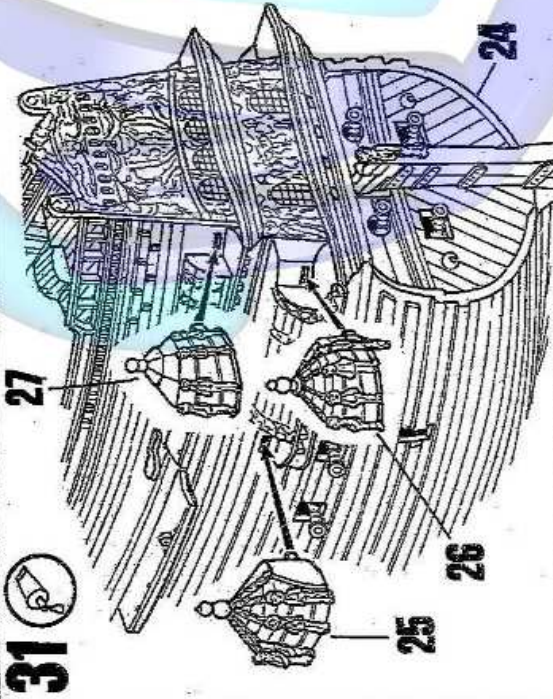

33



34

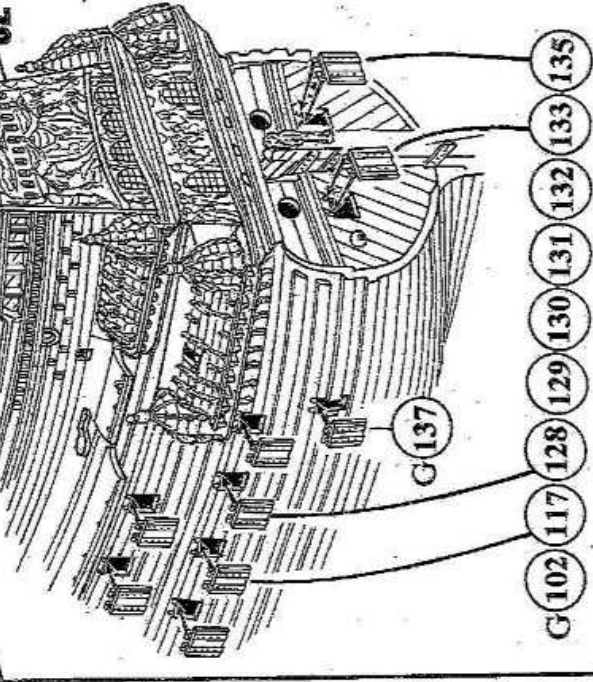
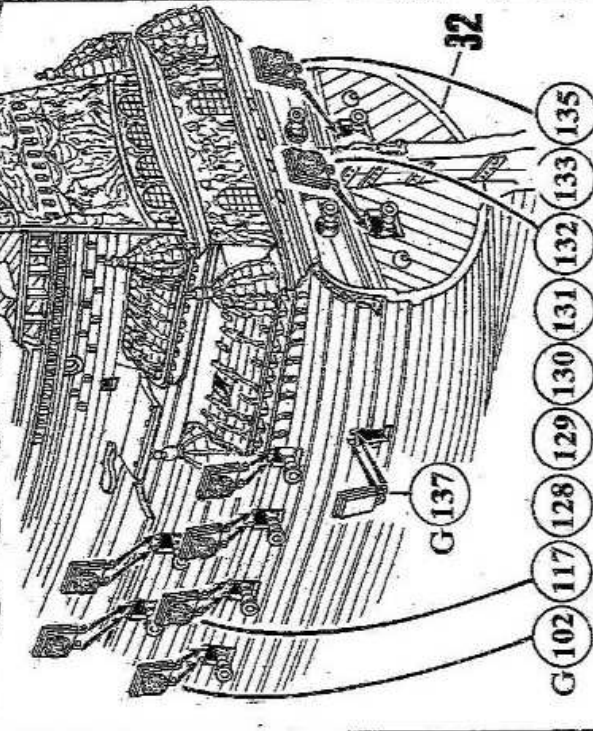

35

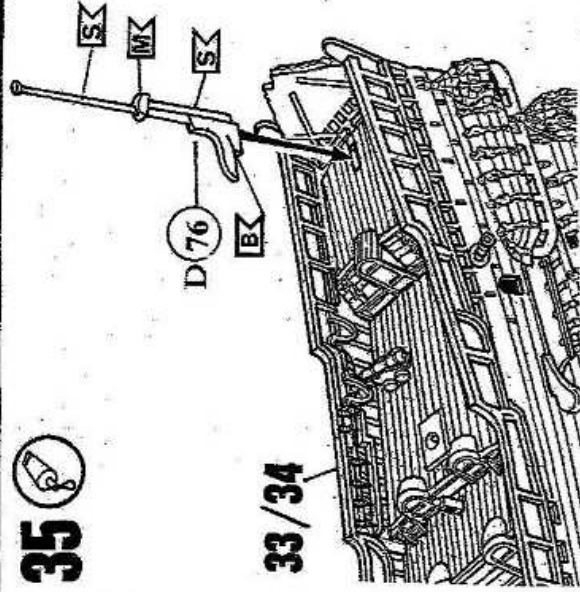

36

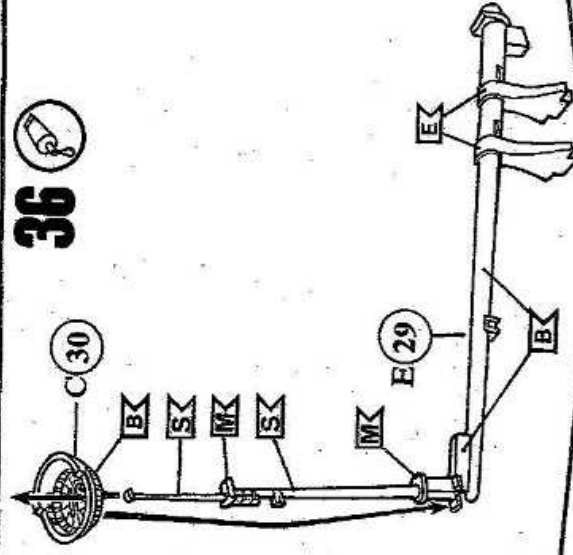

37

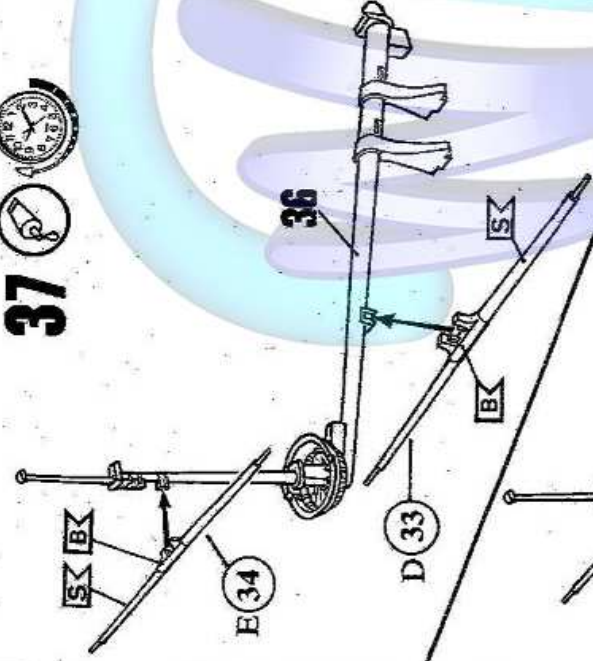

38

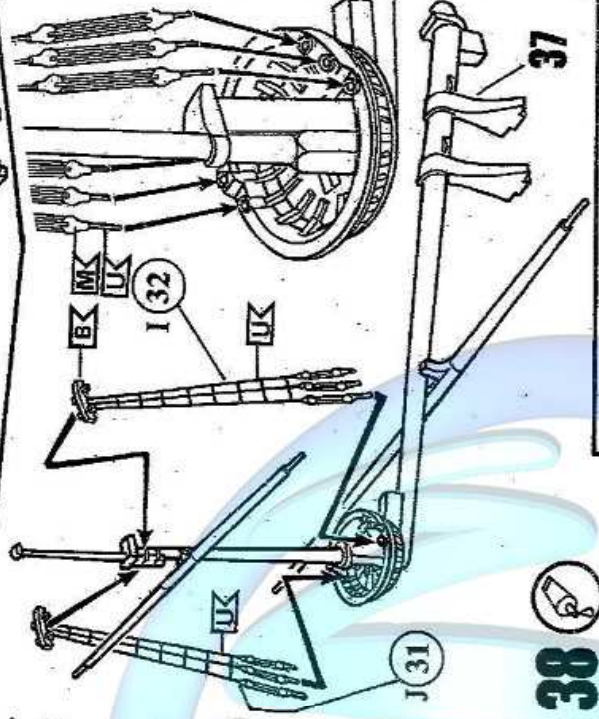

39

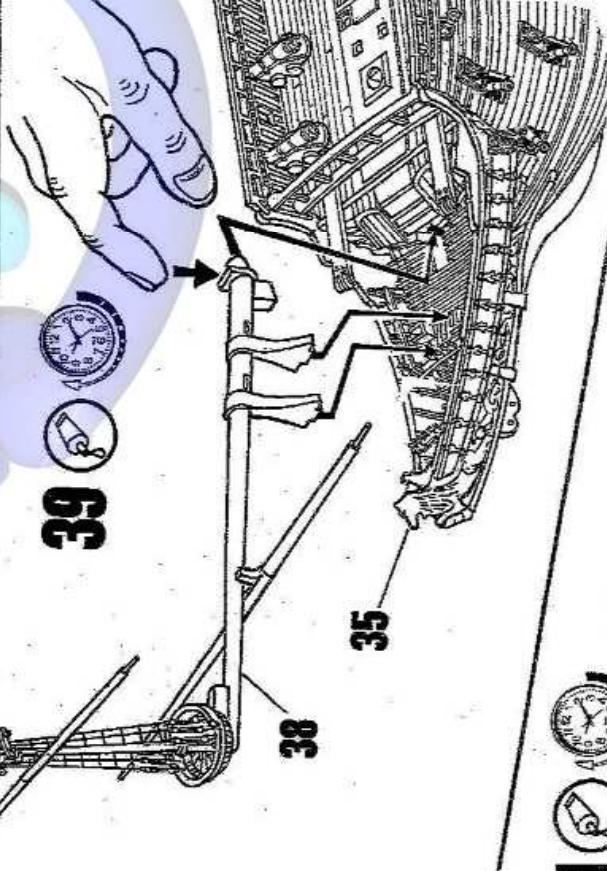

40

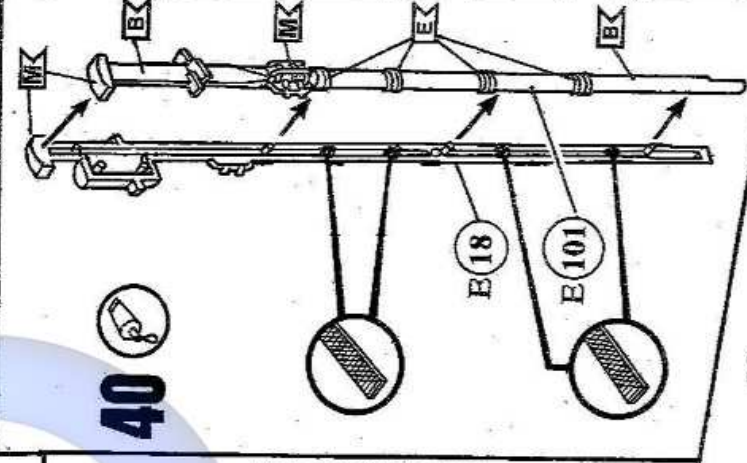

41

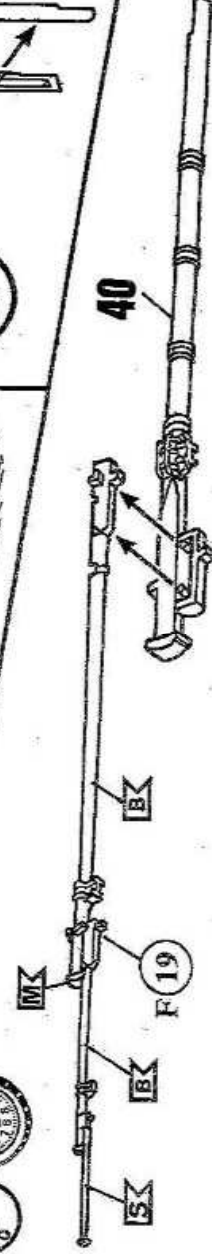

42

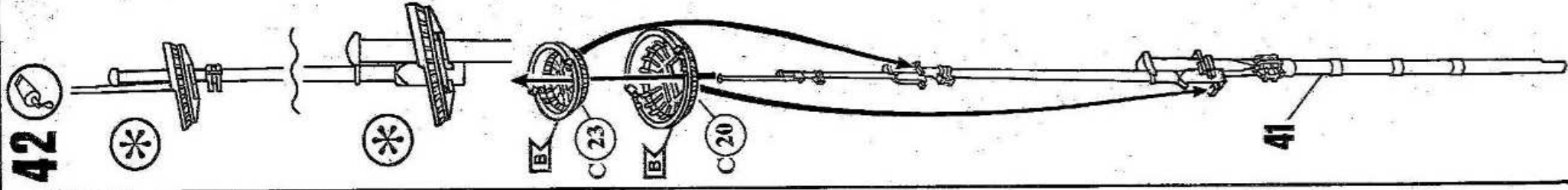

43

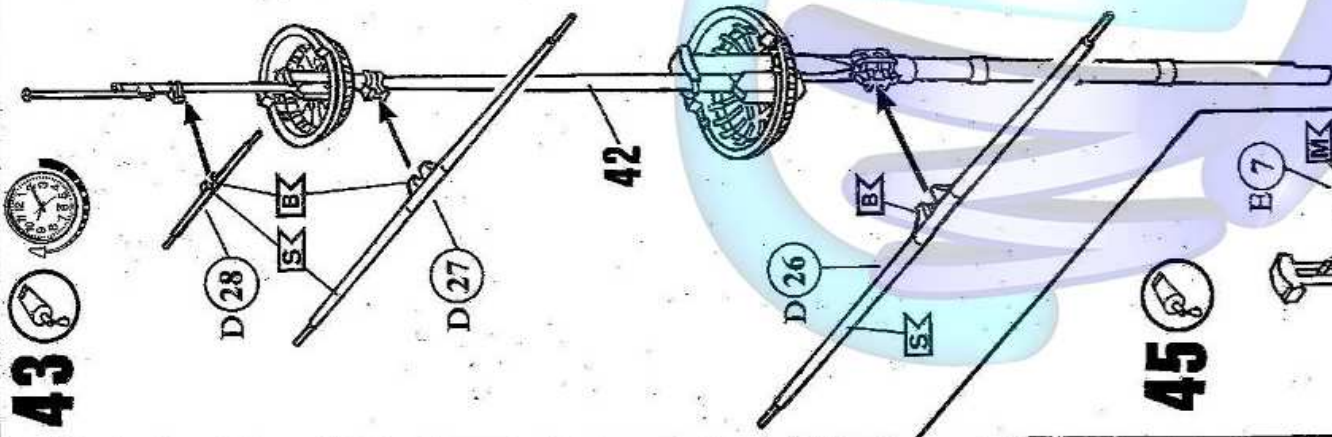

44

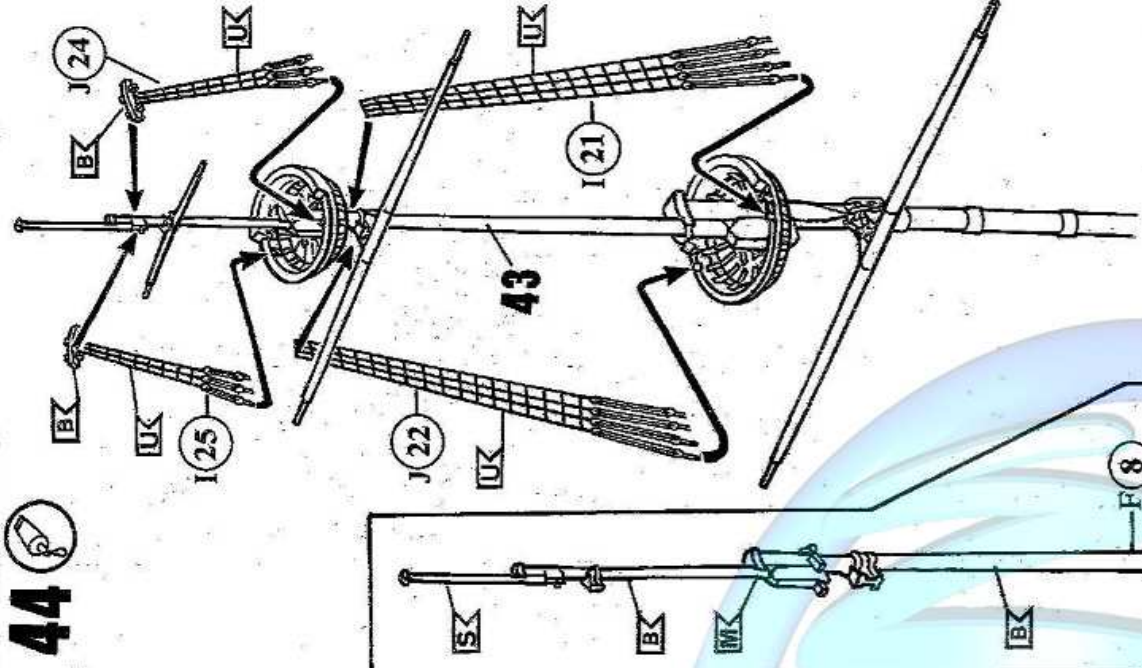

45

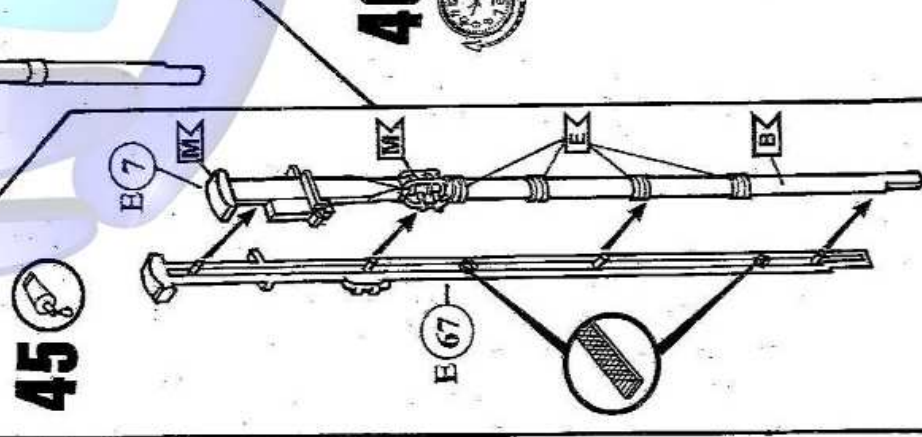

46

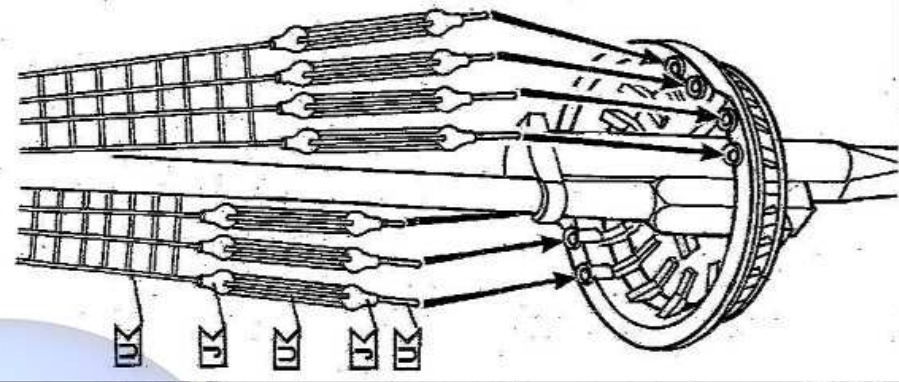
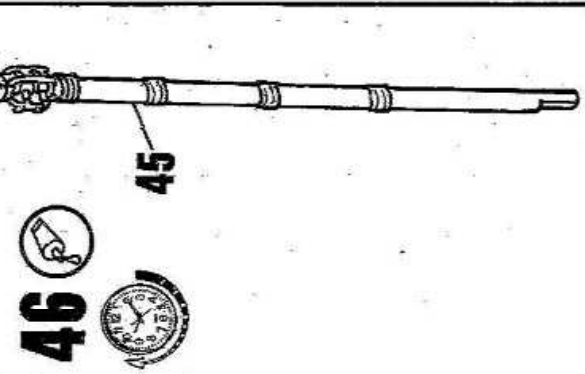

47

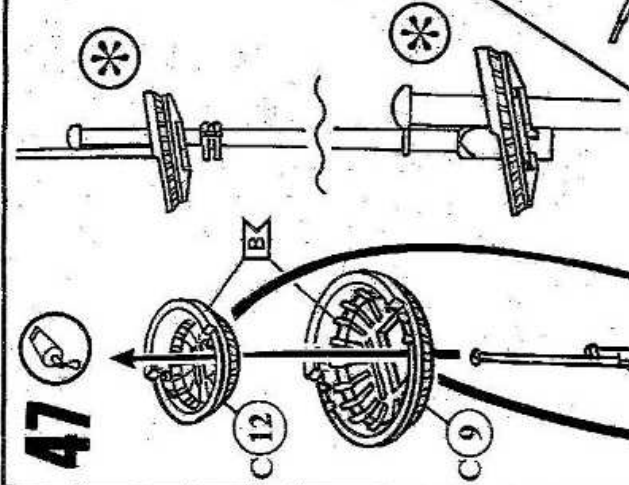

48

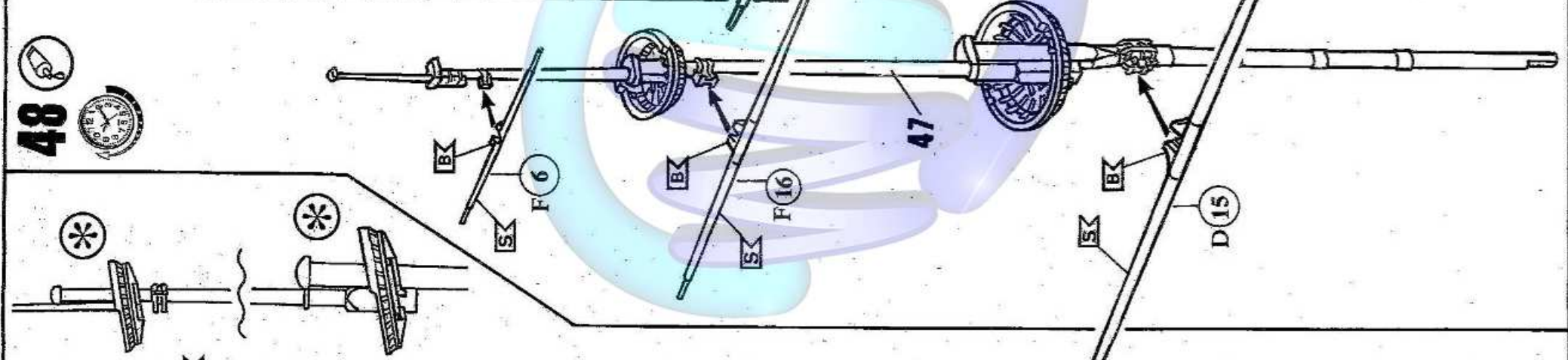

49

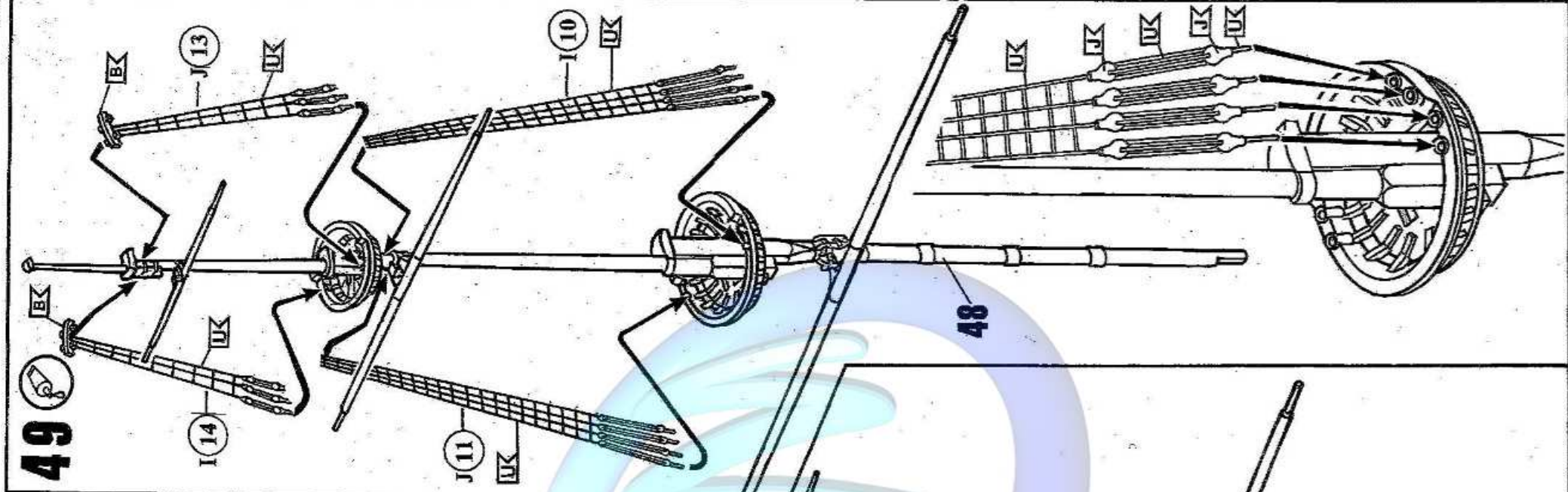

50

51

52

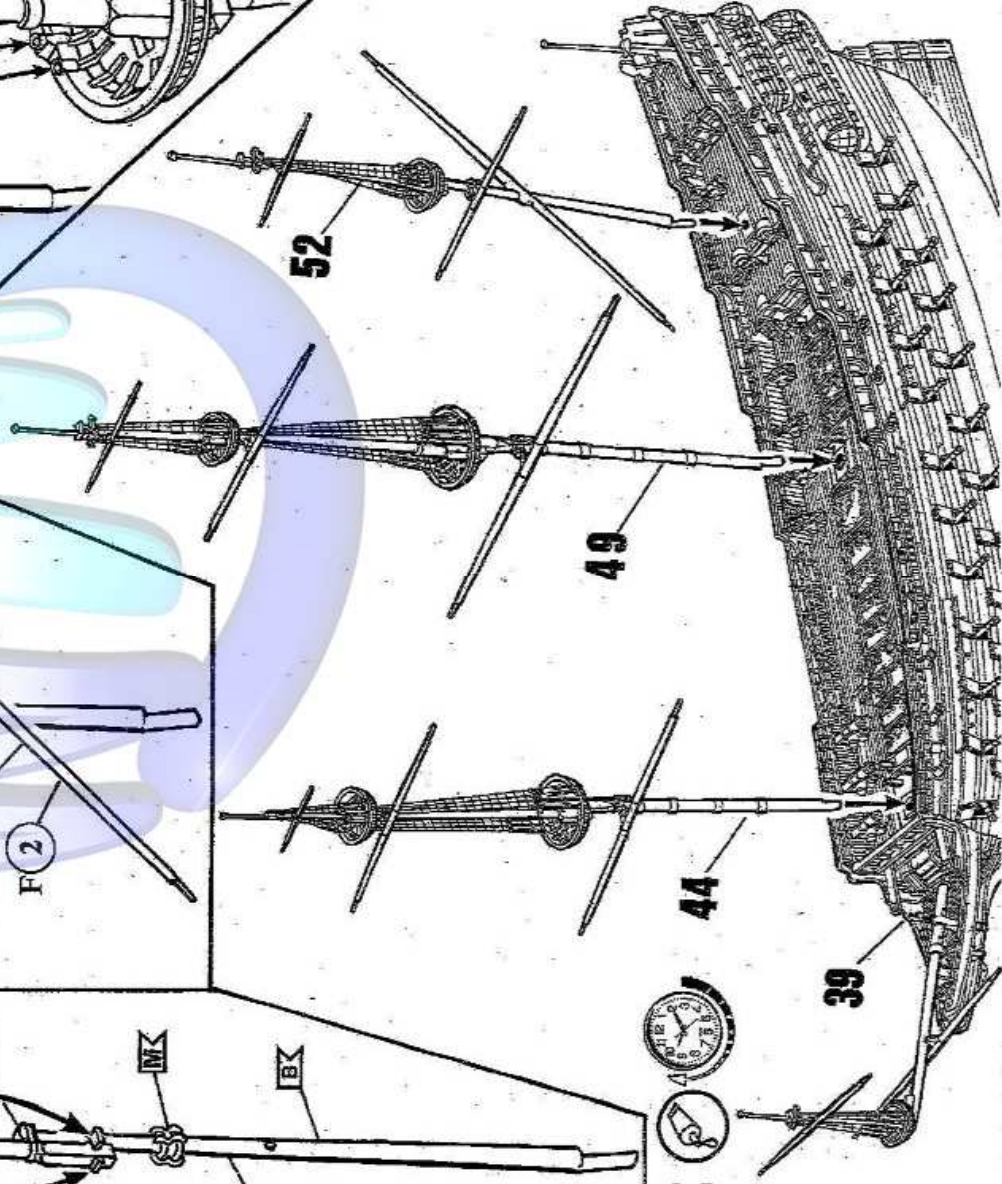
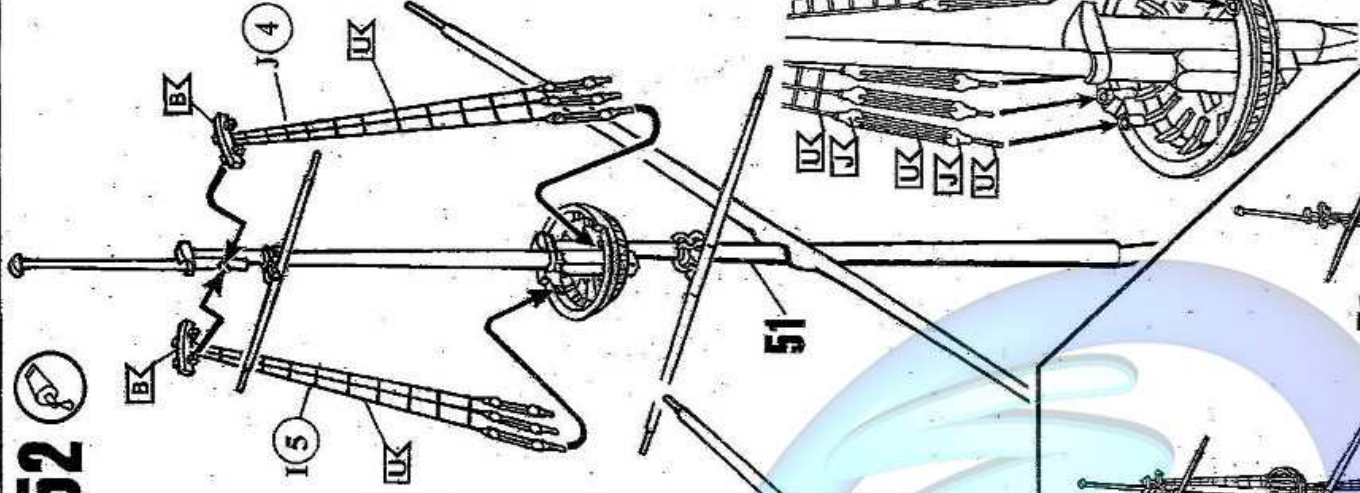
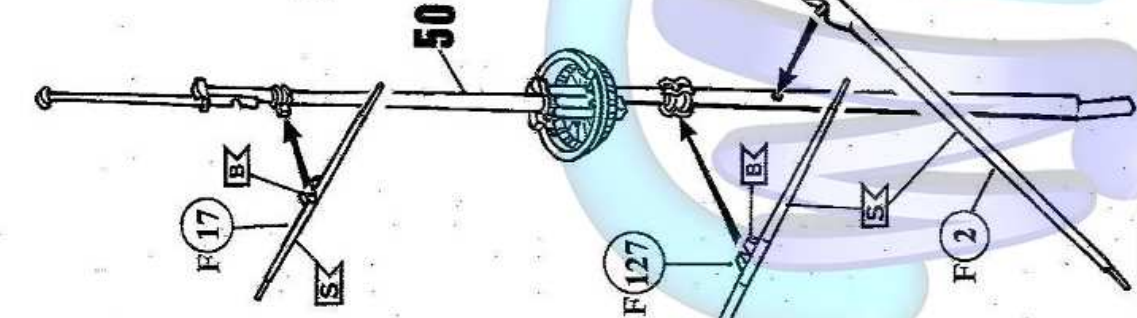
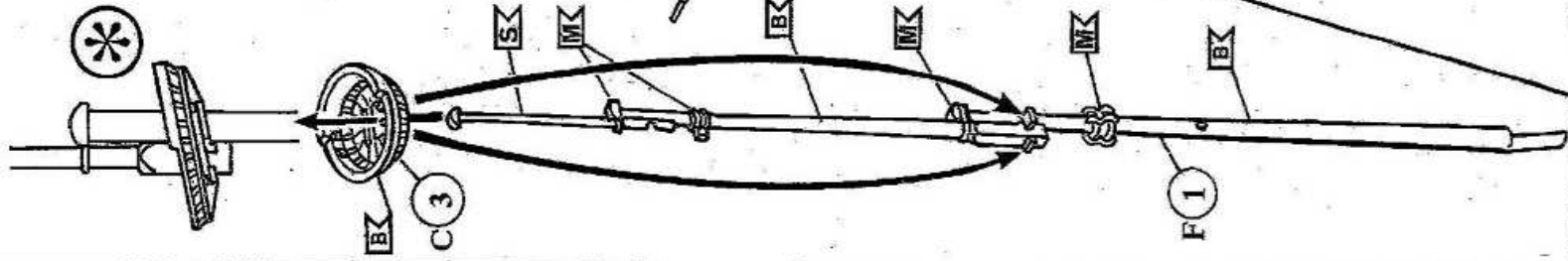

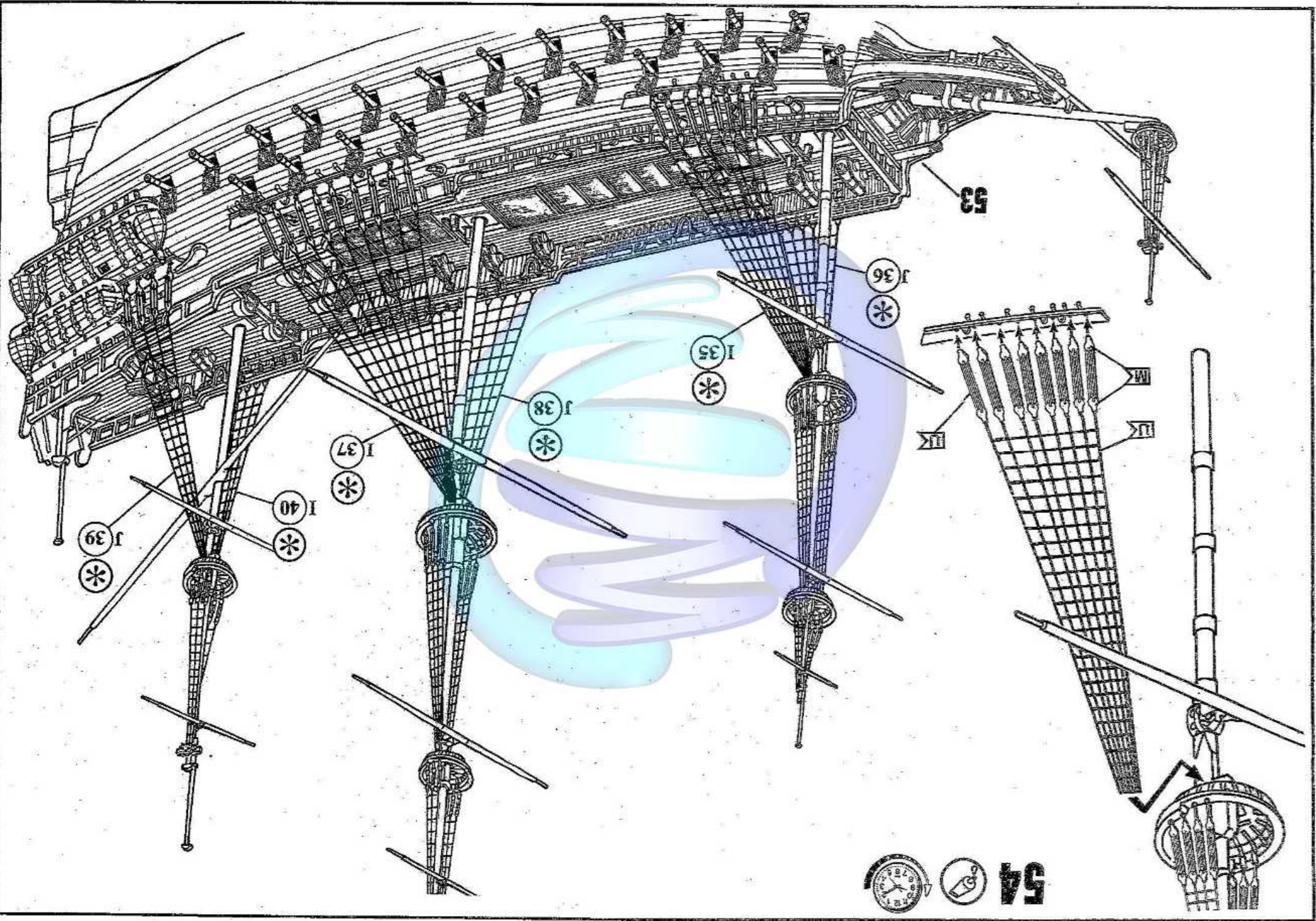

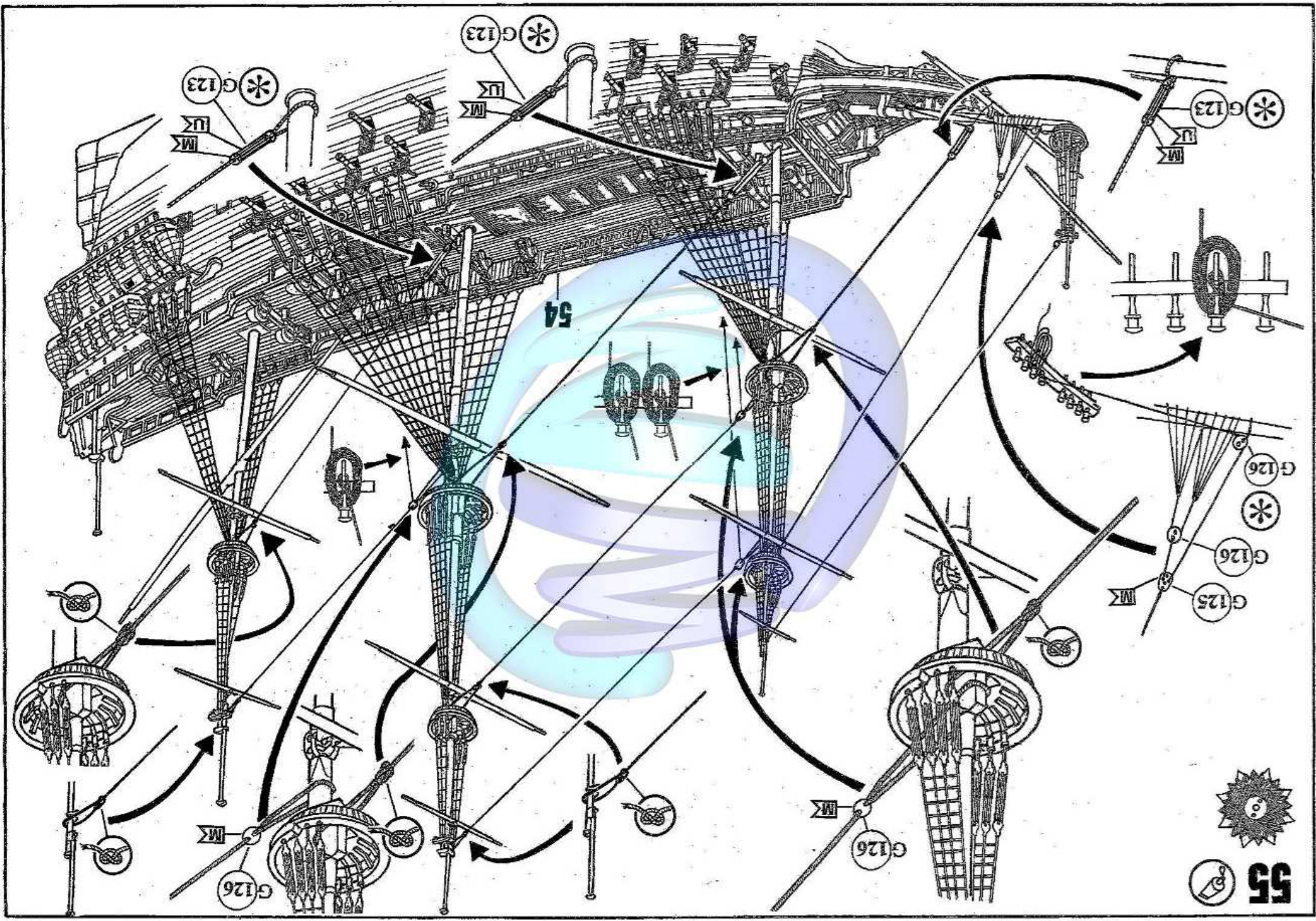

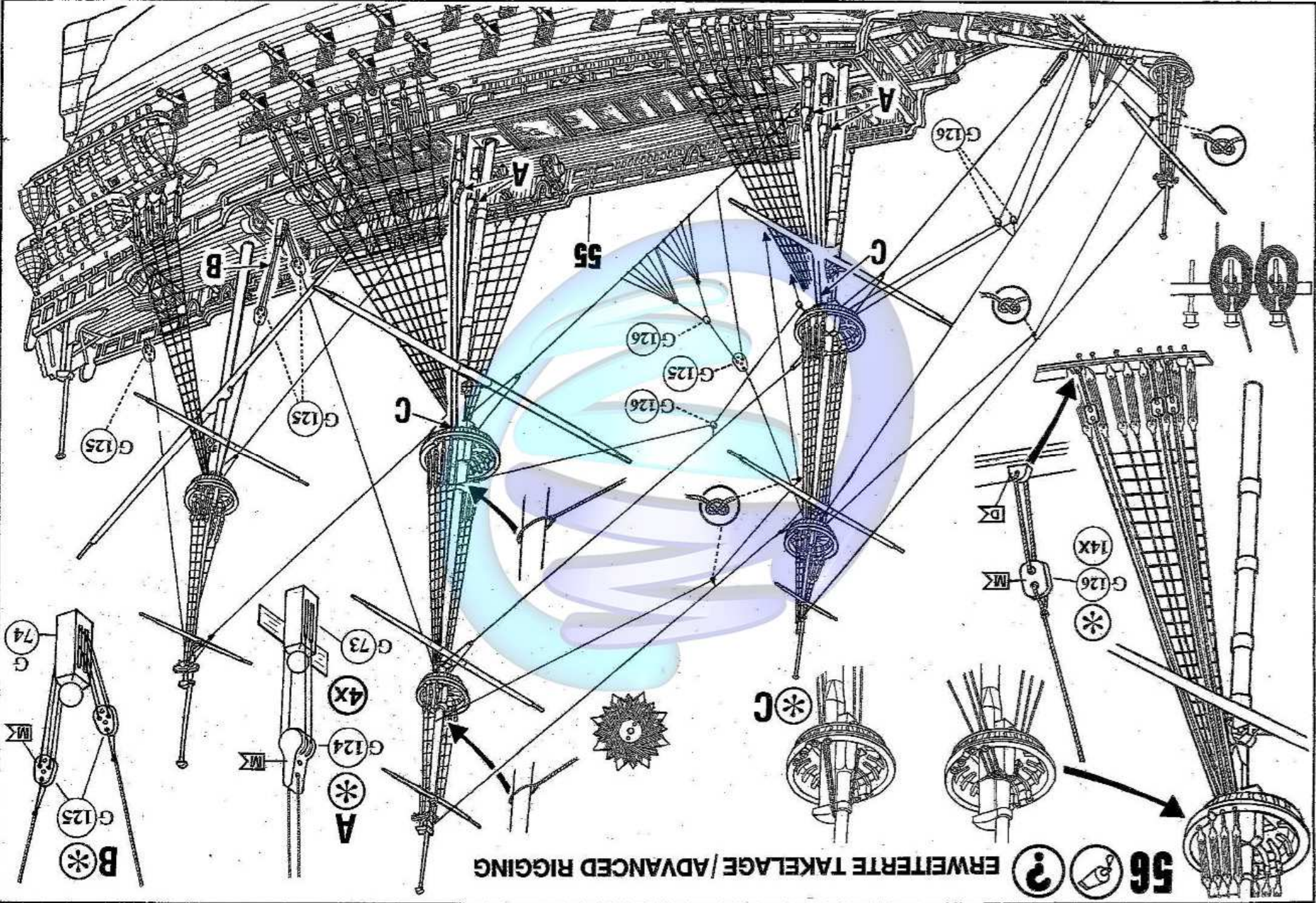



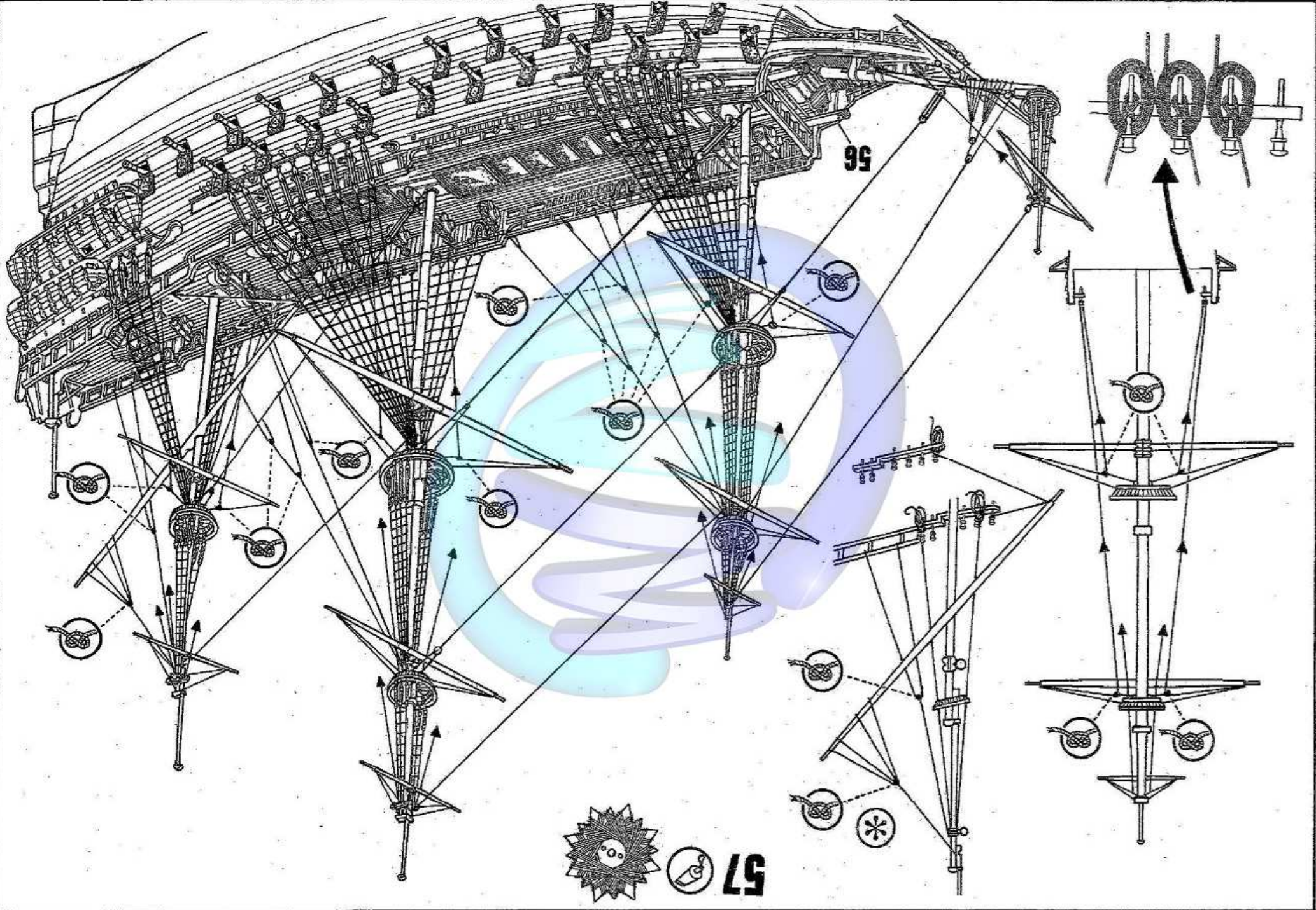

ERWEITERTE TAKELAGE / ADVANCED RIGGING

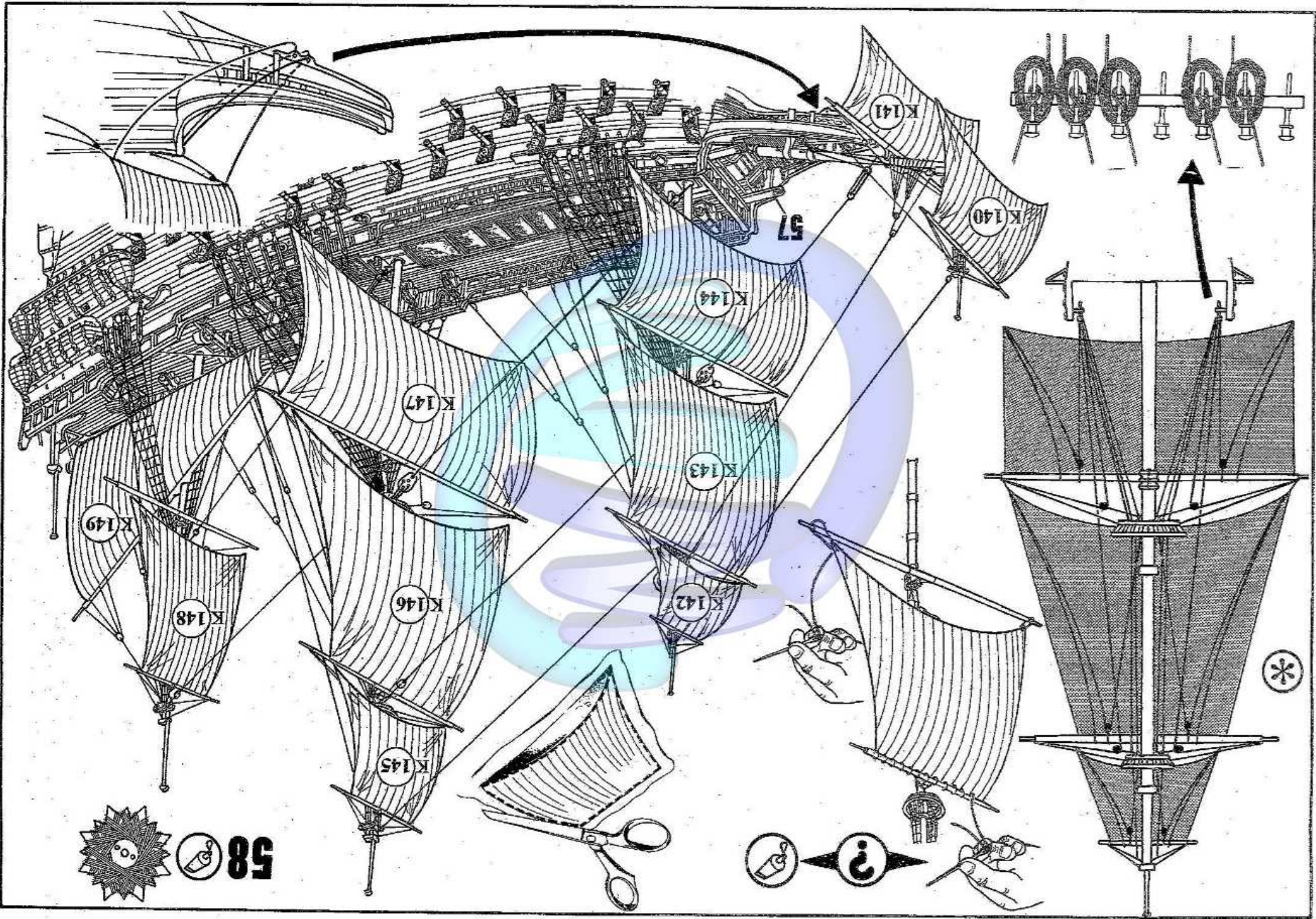
56 ?





  **58**

 



ERWEITERTE TAKELAGE  
ADVANCED RIGGING



59

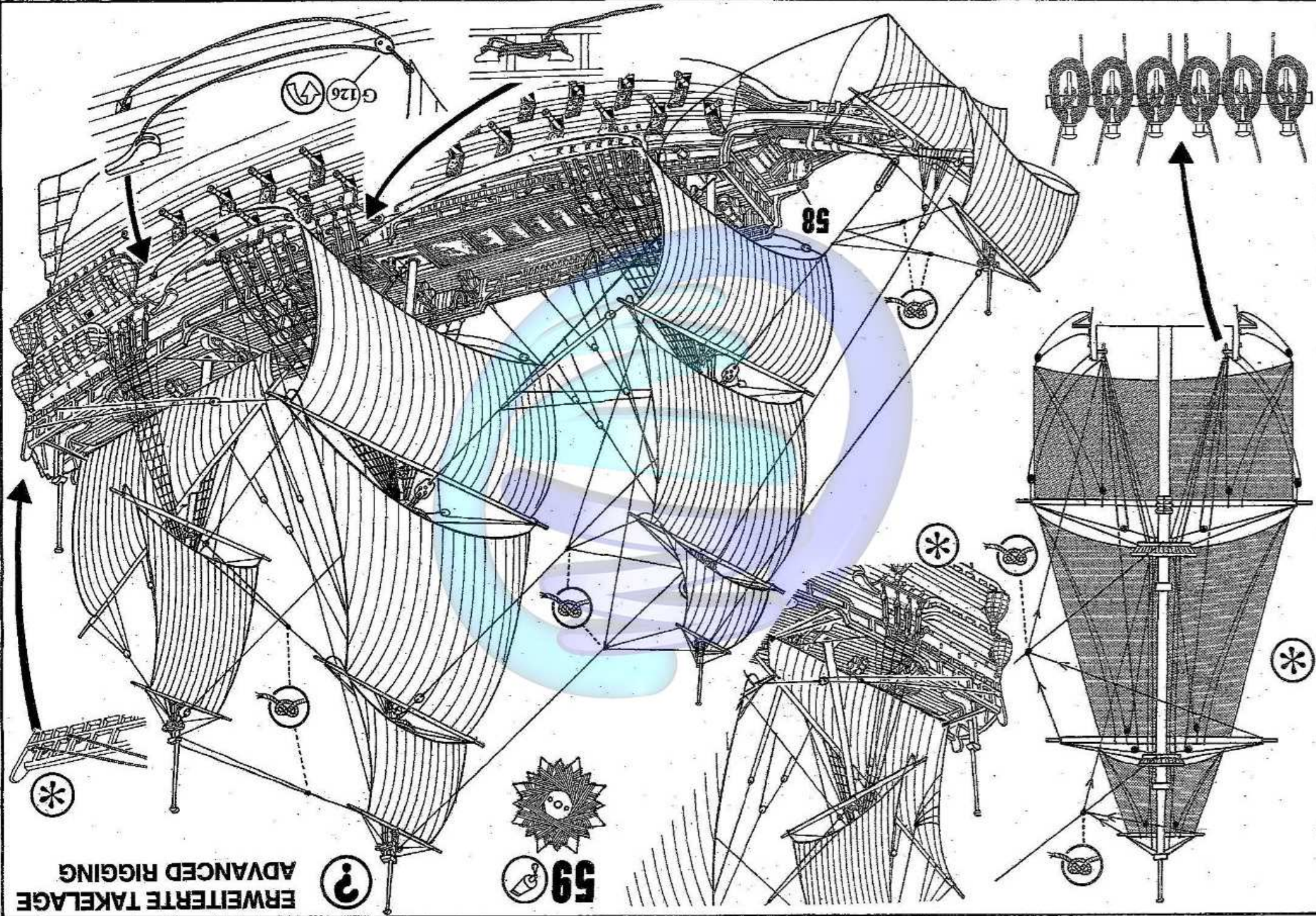

60 2x

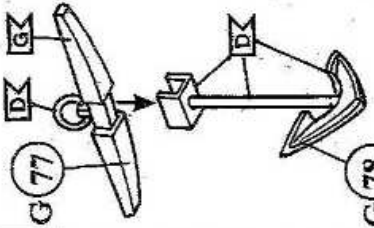

61

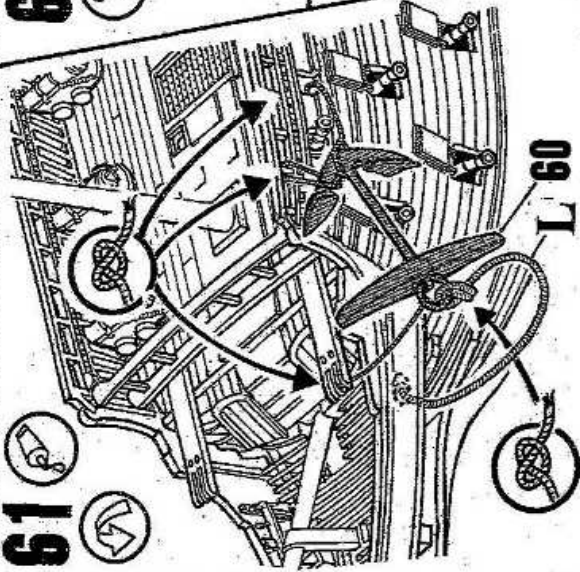

62

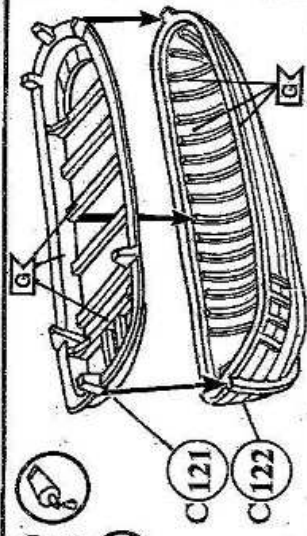

63

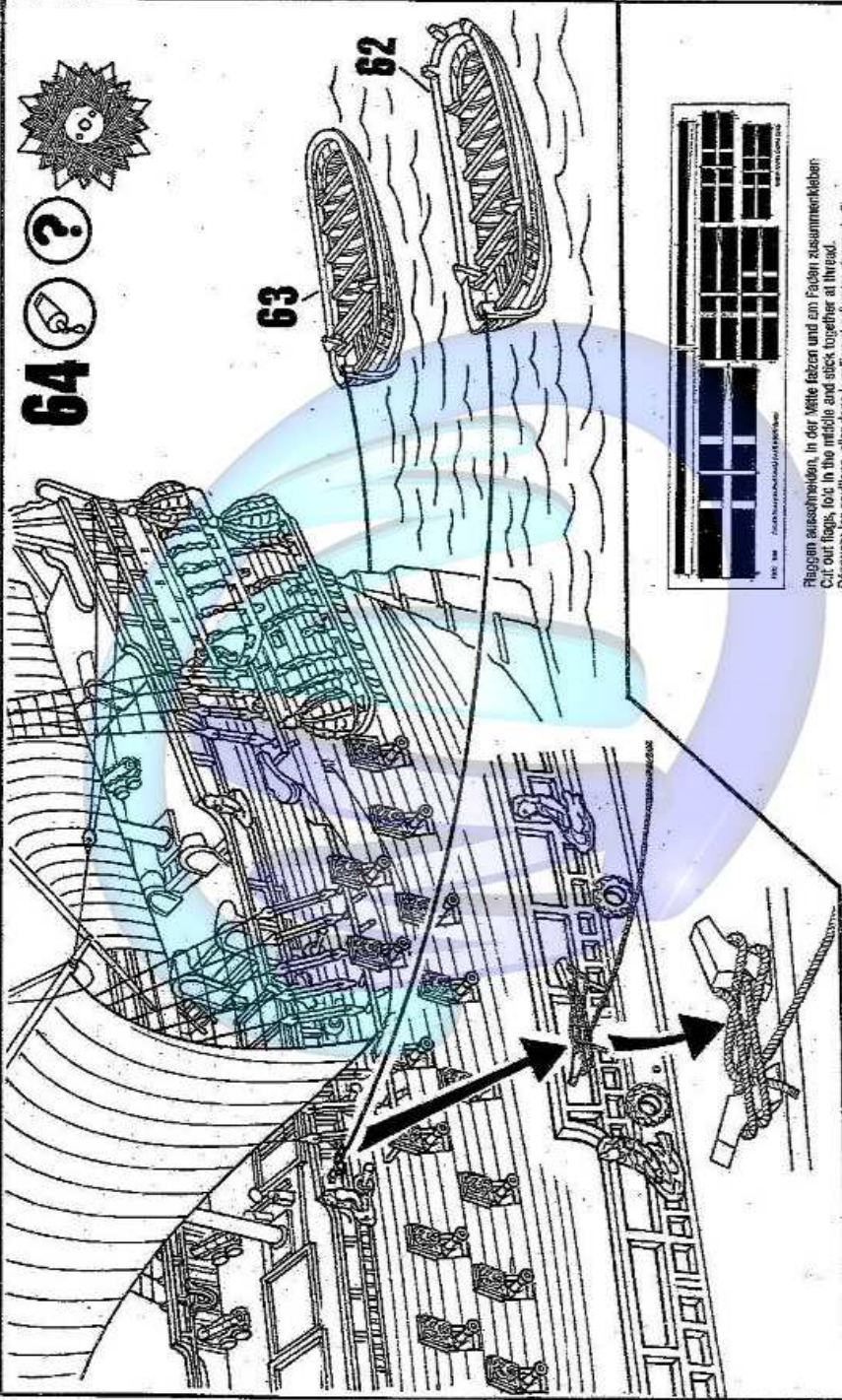
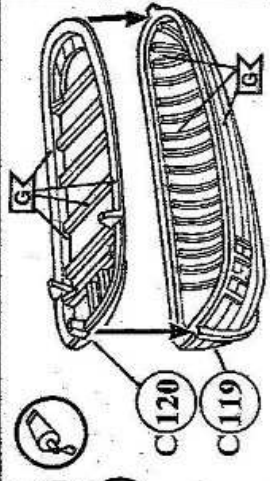

64 ?



65

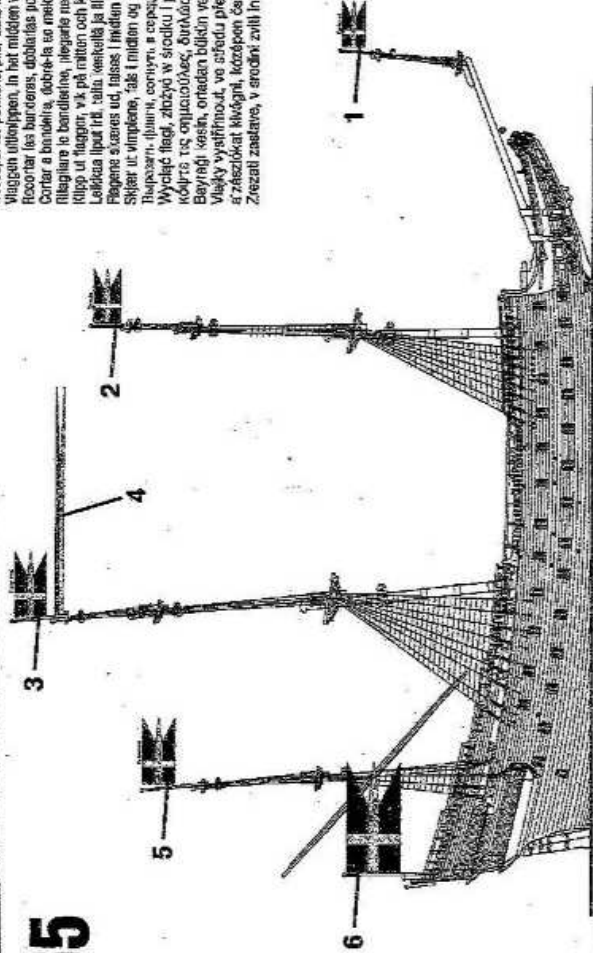

Flaggen zusammenheften. In der Mitte fügen und ein Faden zusammenkleben.

Cut out flags, fit in the middle and stick together at thread.

Вырезать флажки, вставить в середину и склеить по нитке.

Decouper les pavillons, insérer dans le milieu et coller au fil.

Recortar los banderines, doblarlos por la hilacha y pegarlos al hilo.

Coriar e bandéira, dobre-la ao meio e colar ao fio.

Itagliare le bandierine, piegare nella metà e incollare sul filo.

Клеить и флажки, вставить в середину и склеить по нитке.

Leikkää liput irti. Vainkeillä ja limalla närmä ympärillä ylöseen.

Flagene særres ud, lægges i midten og lims omkring tråden.

Skjær ut vimpelene, fås i midten og lim sammen på snora.

Разрезать флажки, сложить в середину и склеить по нитке.

Wyciąć flagę, złożyc w srodku i przykleić do nitki.

Kóvára tes csapóval, dobórta tes a közepén a fonalat ragasztva.

Bevågri flagin, ortadan bökün ve ipilge yapıştırm.

Віаькі вистрижте, в середину підставте а на нитку склепіть.

4zřezovat květinu, křozepn složout a na nřadu skřepřt.

Zrezati zastave, v srodoku zvliti in nalepliti za nit.



Stockholm, 1628

parts 69, 73, 74

