



Boeing 747-8™ Fanhansa Siegerflieger

Die Boeing 747-8 „Siegerflieger“ ist das Flugzeug, mit dem die frisch gekürten deutschen Fußballweltmeister am 14. Juli 2014 zurück nach Deutschland geflogen sind. Der Flug mit der Flugnummer LH 2014 ging direkt von Rio de Janeiro nach Berlin, wo die Mannschaft von hunderttausenden Fans frenetisch gefeiert wurde. Den Schriftzug „Siegerflieger“ hat die Lufthansa zur Feier des Triumpfs direkt nach dem gewonnenen Finale innerhalb weniger Stunden in Rio de Janeiro aufgebracht. Auch das Flugzeug war dem Anlass angemessen; schließlich weckt die Boeing 747 wie kaum ein anderes Verkehrsflugzeug viele Emotionen und wird daher auch liebevoll „Jumbo“ genannt. Die aktuelle Version 747-8 überzeugt durch zahlreiche Innovationen, fortschrittliche Technologie und Effizienz. Der Lufthansa-Jumbo bietet insgesamt 362 Passagieren Platz. Nach seinem besonderen Flug wird der Siegerflieger als Motivation für die Spieler sogar noch bis zur Europameisterschaft 2016 im Linienflug unterwegs sein.

Die 747-8 hat einen um 5,6 m (220 in.) längeren Rumpf als die 747-400 und weist viele neue Merkmale auf, wie ein superkritisches Flügelprofil, hochgebogene Flügelspitzen, dann Spatitklappen, die nur einen oder zwei Spalte aufweisen und die die dreispaltigen, schwereren und komplexeren Klappen der älteren Versionen der 747 ersetzen, und nicht zuletzt das neue General Electric GENx-Triebwerk. Ergänzt um die Cockpit- und Kabinentechnologie der 787 bewirken alle Verbesserungen zusammen eine deutliche Treibstoffspareis gegenüber allen vorherigen Modellen der 747-Serie. Bei sehr dichter Bestuhlung können bis zu 605 Passagiere in der 747-8 Platz nehmen, wobei die meisten Fluglinien bei einer Aufteilung in mehrere Klassen maximal 467 Passagiere befördern. Der Triebwerkstyp General Electric GENx wurde speziell für die 747-8 und die 787 entwickelt. Es handelt sich dabei um das größte und leistungsstärkste Triebwerk, das jemals bei einem 747-Modell eingebaut wurde, mit einer Schubkraft von bis zu 296 kN (66.500 lbs.). Bei der 747-8 wird das GENx-2B67 verwendet, dessen Turbinenschauflrad einen Durchmesser von 2,67 m (105 in.) hat, und das sowohl Lärmemissionen als auch Luftverschmutzung erheblich reduziert und gleichzeitig eine effizientere Treibstoffausnutzung bewirkt. Die Lufthansa war die erste Fluggesellschaft, die die Passagierversion der 747-8 in Dienst stellte. Sie erhält bis 2015 insgesamt 20 Maschinen dieses Typs.

Boeing 747-8™ Fanhansa Siegerflieger

The Boeing 747-8 "Siegerflieger" (Champions Aircraft) is the aircraft in which the newly crowned German football World Champions flew back to Germany on 14 July 2014. Flight number LH 2014 routed direct from Rio de Janeiro to Berlin where the team were given a tumultuous reception by hundreds of thousands of fans. Within a few hours of the final whistle, Lufthansa decided to apply the Logo "Siegerflieger" to celebrate the teams success directly in Rio de Janeiro. Even the aircraft was appropriate for the occasion. The Boeing 747 awakens more emotion than any other aircraft and is therefore also affectionately known as "Jumbo". The current version - the 747-8 has many convincing innovations based on advanced technology and efficiency. The Lufthansa Jumbo has seating for a total of 362 passengers. After its initial series of flights it's been decided to keep the special livery in service until the European Championship in 2016, to act as extra motivation for the team.

Featuring a fuselage stretch of 220 inches (5,6 m) over the 747-400, the 747-8 incorporates many new features such as a supercritical airfoil, a raked wing tips, single and double-slotted flaps replacing the heavier and more complex triple-slotted flaps on older 747s, and the new General Electric GENx engine. Along with 787 cockpit and cabin technology, these improvements result in marked fuel economy over all previous 747 models. The 747-8 is capable of carrying up to 605 passengers in high density configuration, although most airlines carry a maximum of 467 in mixed class configurations. General Electric's GENx engine was designed specifically for the 747-8 and 787. It is the largest and most powerful engine ever fitted to any 747 model, and is capable of producing up to 66,500 lbs (296 kN) of thrust. The GENx-2B67 fitted to the 747-8 has a 105 inch diameter fan, and significantly reduces the noise signature and pollution of the 747-8 as well as increasing fuel efficiency. Lufthansa was the first airline to put the passenger version into service. Lufthansa will take delivery of 20 Boeing 747-8 by 2015.



Produced under license, Boeing, 747 and the distinctive Boeing logos, product markings and trade dress are trademarks of the Boeing Company

747™

Forma licencomitell ja loogitud Revell GmbH. Väärreprodutseeritud kopeeringud võivad olla ebaseadlikud.

© 2014 by Revell GmbH. A subsidiary of Hobbico, Inc. All rights reserved. Boeing, 747 and the distinctive Boeing logos, product markings and trade dress are trademarks of the Boeing Company.

Modell ja selle kujundus on registreeritud Revell GmbH. Kõik muud sarnased kujundused võivad olla ebaseadlikud.

Forma licencomitell ja loogitud Revell GmbH. Väärreprodutseeritud kopeeringud võivad olla ebaseadlikud.

Modell ja selle kujundus on registreeritud Revell GmbH. Kõik muud sarnased kujundused võivad olla ebaseadlikud.

Forma licencomitell ja loogitud Revell GmbH. Väärreprodutseeritud kopeeringud võivad olla ebaseadlikud.

Modell ja selle kujundus on registreeritud Revell GmbH. Kõik muud sarnased kujundused võivad olla ebaseadlikud.

Forma licencomitell ja loogitud Revell GmbH. Väärreprodutseeritud kopeeringud võivad olla ebaseadlikud.

Modell ja selle kujundus on registreeritud Revell GmbH. Kõik muud sarnased kujundused võivad olla ebaseadlikud.

Forma licencomitell ja loogitud Revell GmbH. Väärreprodutseeritud kopeeringud võivad olla ebaseadlikud.

Modell ja selle kujundus on registreeritud Revell GmbH. Kõik muud sarnased kujundused võivad olla ebaseadlikud.

Forma licencomitell ja loogitud Revell GmbH. Väärreprodutseeritud kopeeringud võivad olla ebaseadlikud.

Modell ja selle kujundus on registreeritud Revell GmbH. Kõik muud sarnased kujundused võivad olla ebaseadlikud.

Forma licencomitell ja loogitud Revell GmbH. Väärreprodutseeritud kopeeringud võivad olla ebaseadlikud.

Modell ja selle kujundus on registreeritud Revell GmbH. Kõik muud sarnased kujundused võivad olla ebaseadlikud.

Forma licencomitell ja loogitud Revell GmbH. Väärreprodutseeritud kopeeringud võivad olla ebaseadlikud.

Modell ja selle kujundus on registreeritud Revell GmbH. Kõik muud sarnased kujundused võivad olla ebaseadlikud.

Forma licencomitell ja loogitud Revell GmbH. Väärreprodutseeritud kopeeringud võivad olla ebaseadlikud.

Modell ja selle kujundus on registreeritud Revell GmbH. Kõik muud sarnased kujundused võivad olla ebaseadlikud.

Forma licencomitell ja loogitud Revell GmbH. Väärreprodutseeritud kopeeringud võivad olla ebaseadlikud.

Modell ja selle kujundus on registreeritud Revell GmbH. Kõik muud sarnased kujundused võivad olla ebaseadlikud.

Forma licencomitell ja loogitud Revell GmbH. Väärreprodutseeritud kopeeringud võivad olla ebaseadlikud.

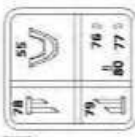
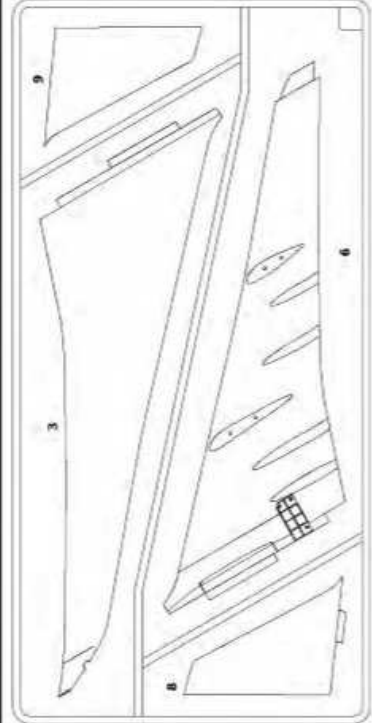
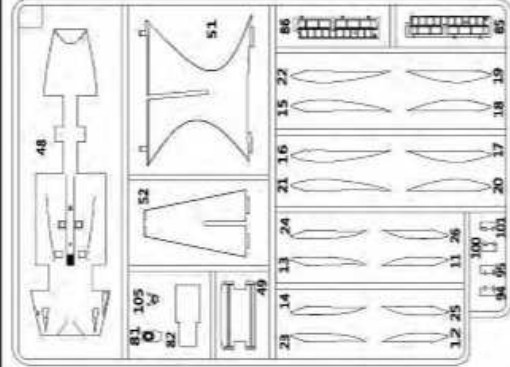

2x

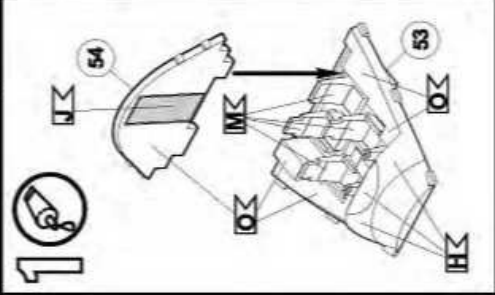
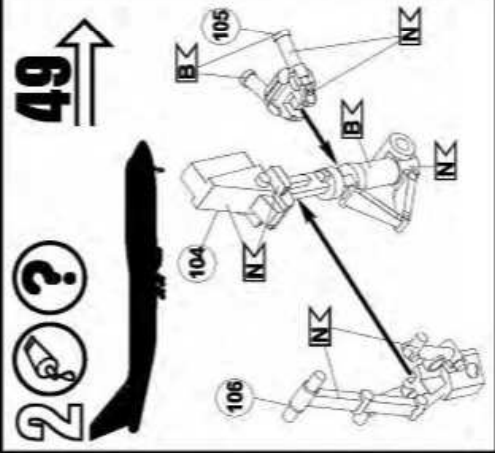
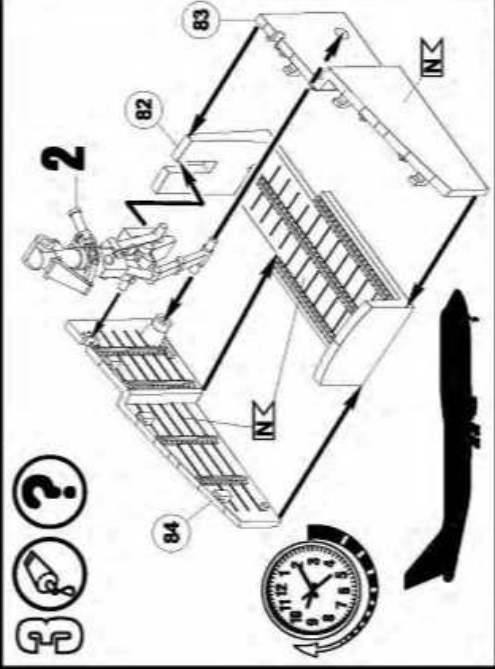
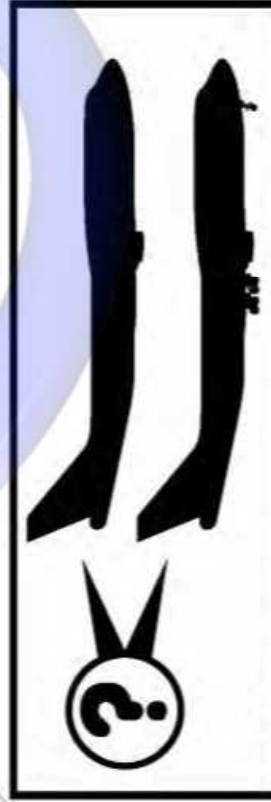
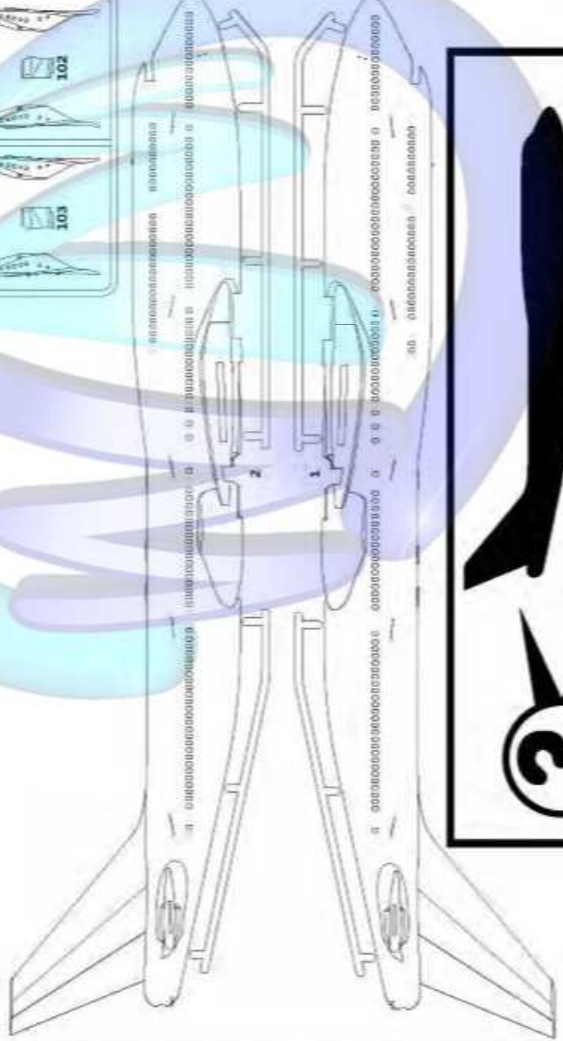
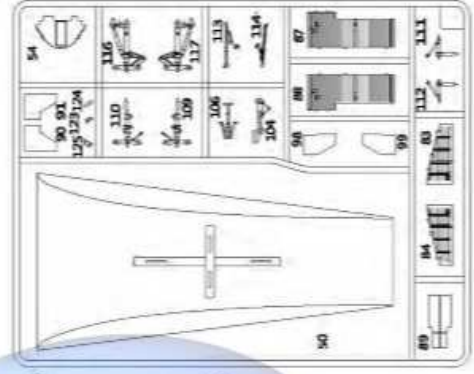
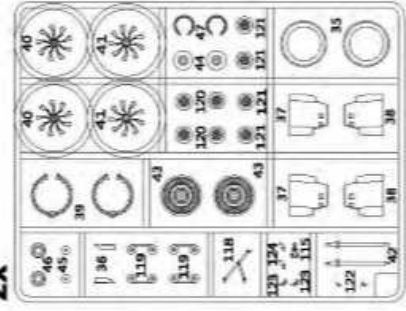

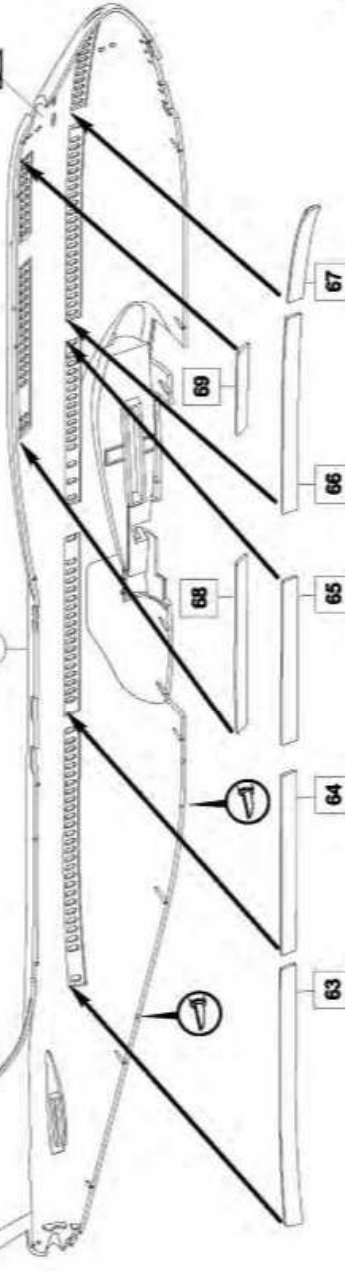
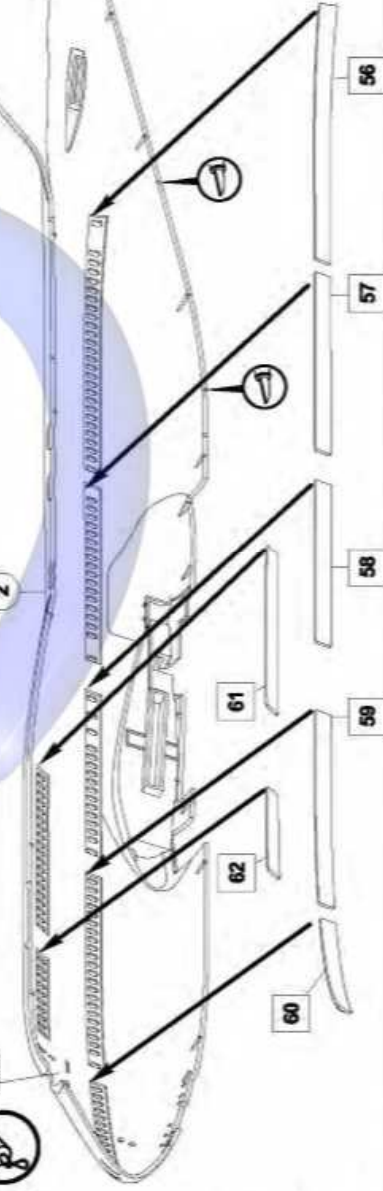
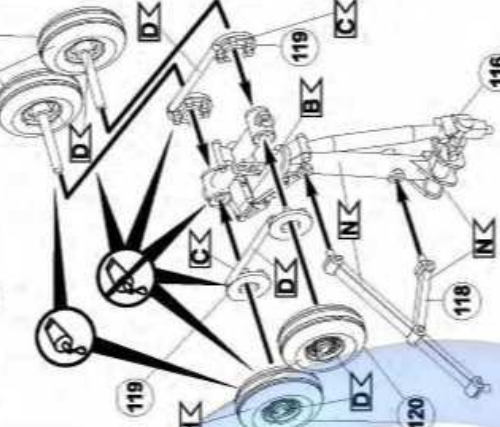
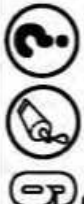
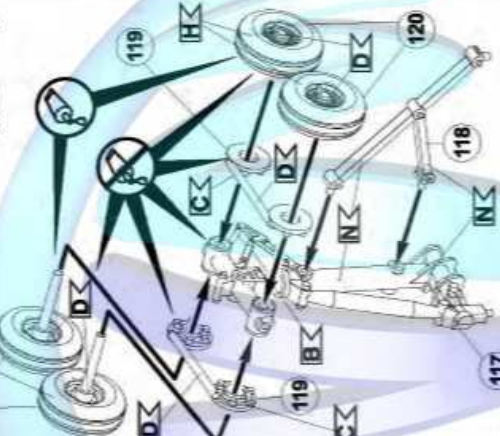
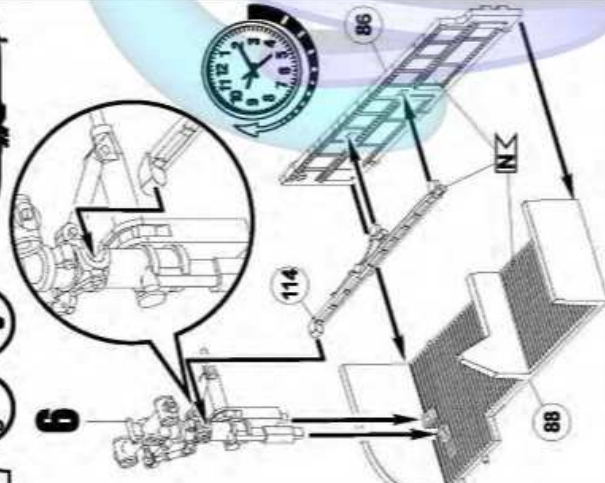
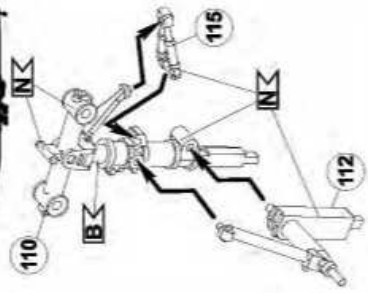
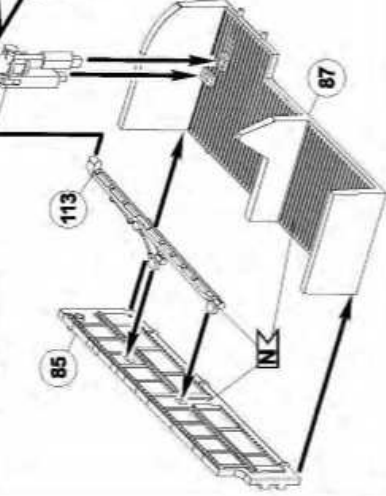
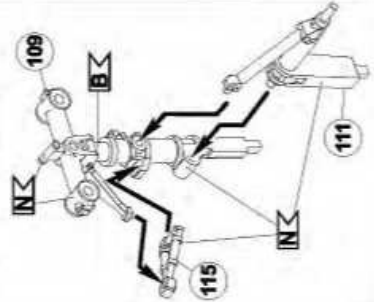

12



13

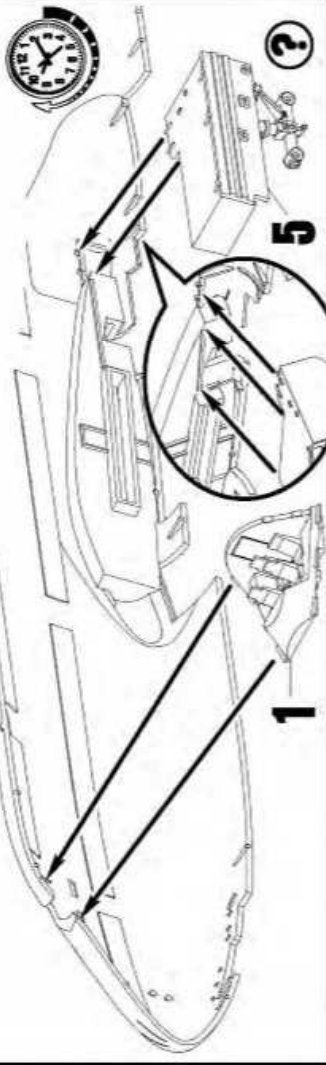
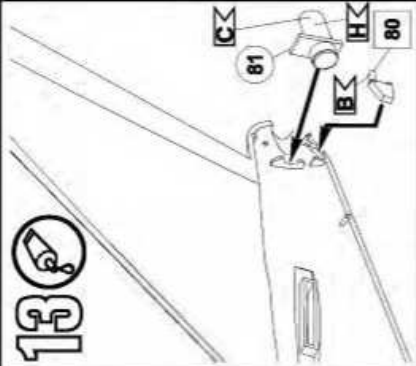

5

1

14

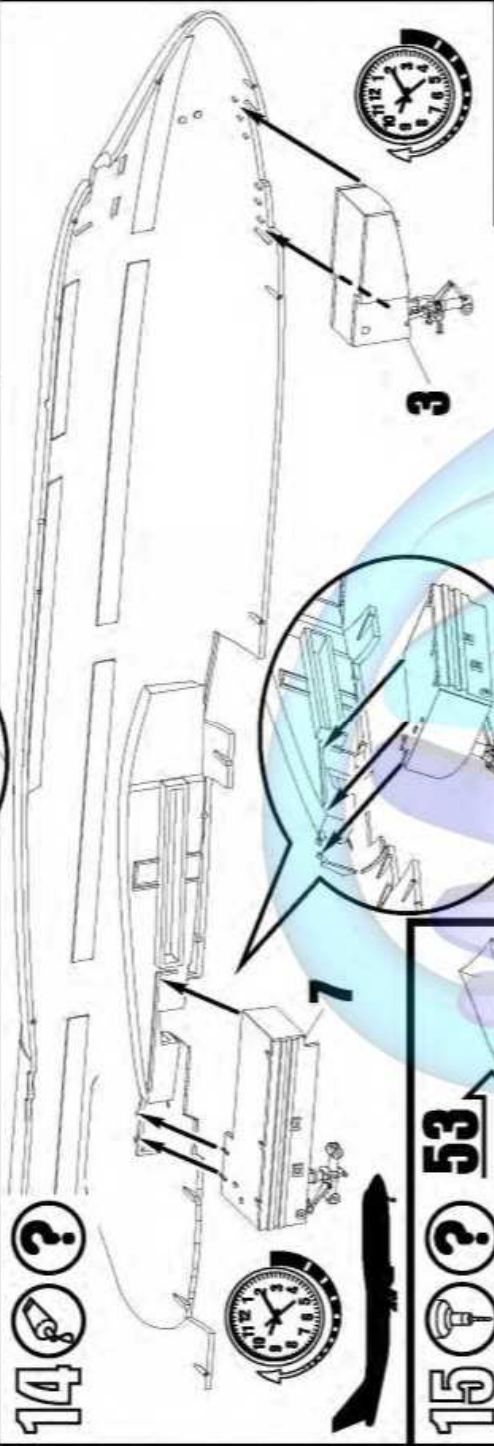

7



3

15



53

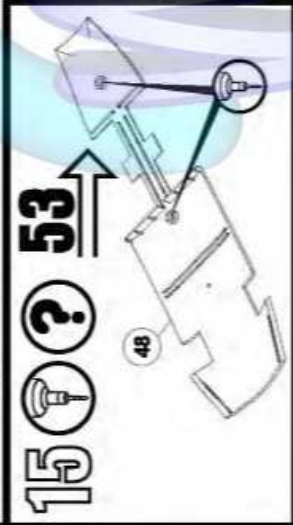

48

16

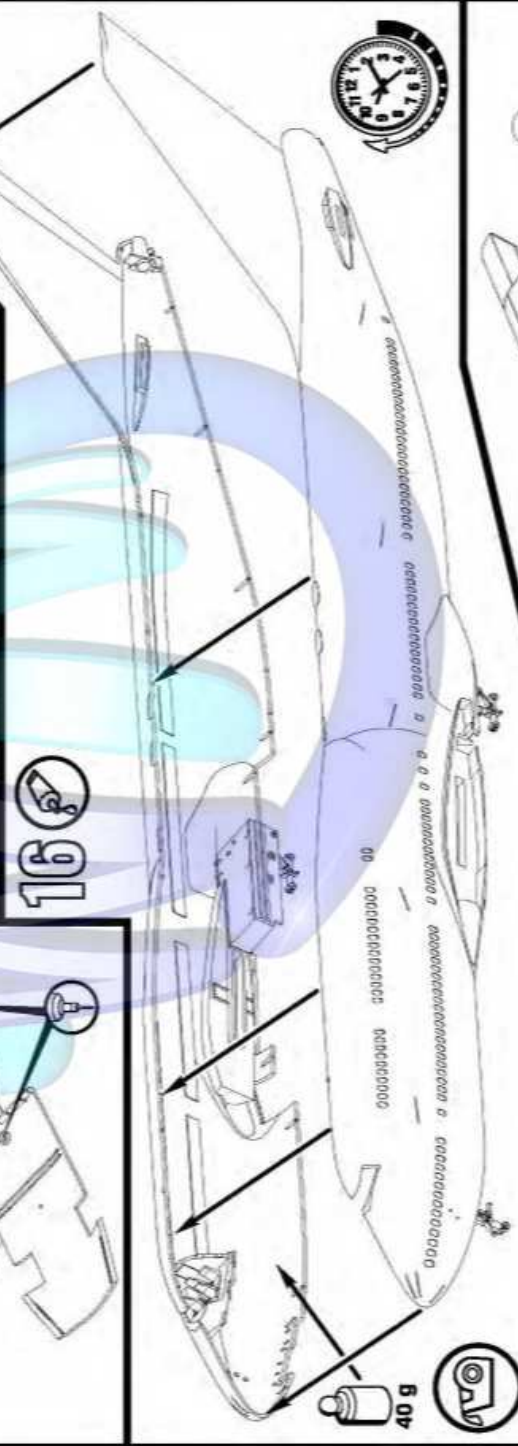

40 g

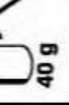

17

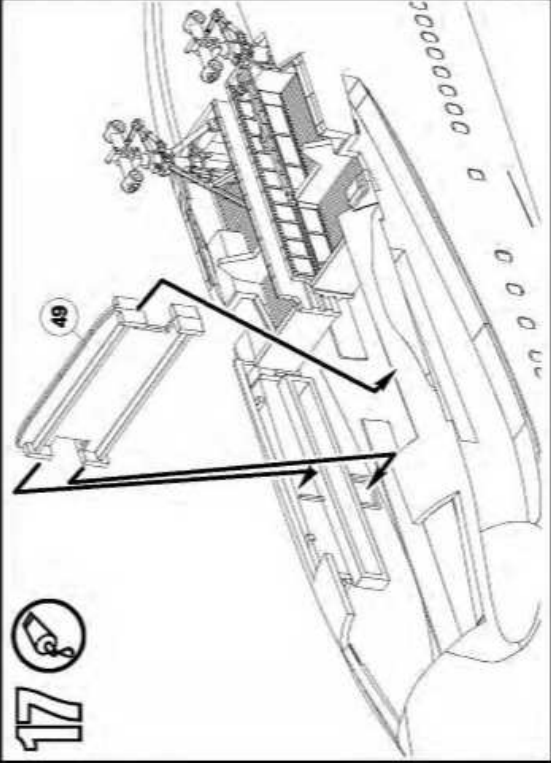

49

18

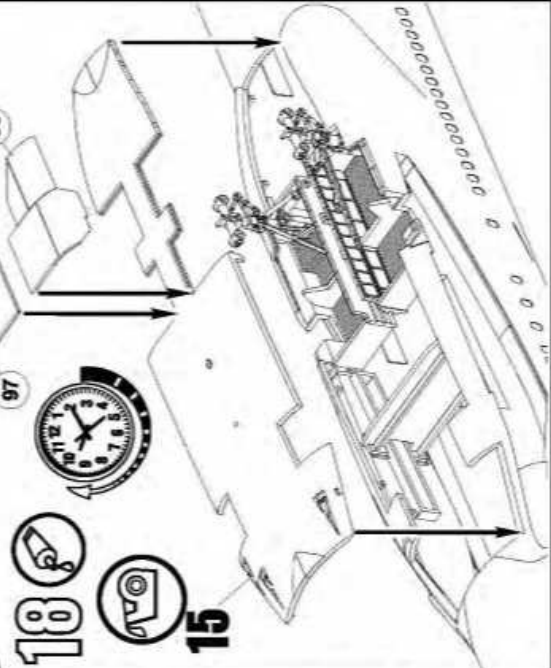

15

97

96

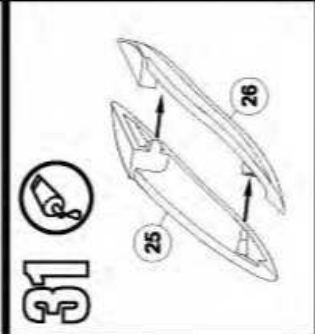
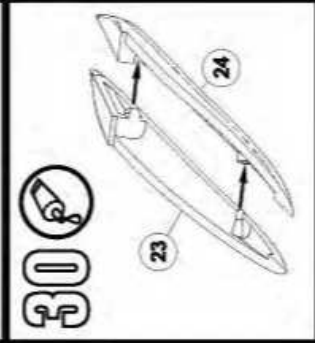
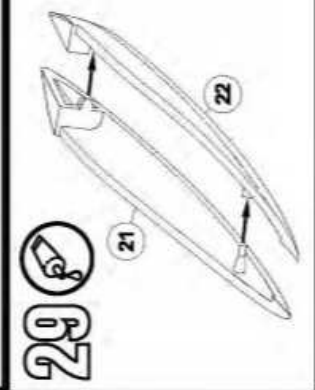
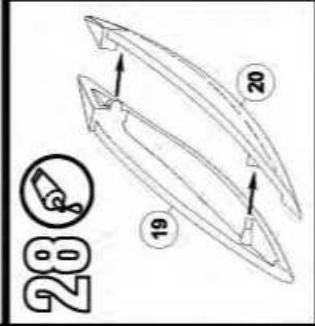
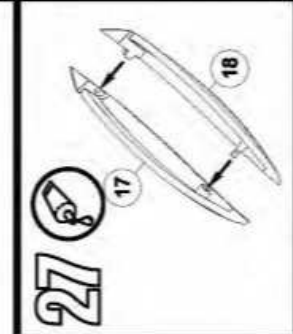
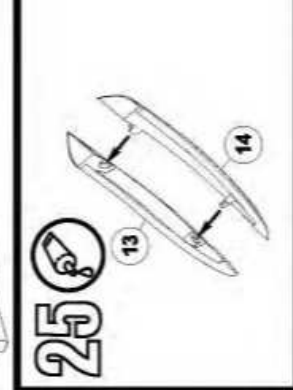
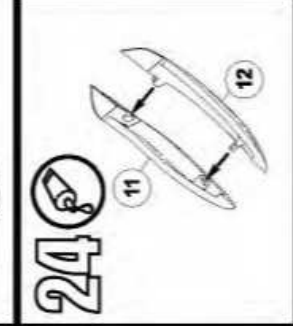
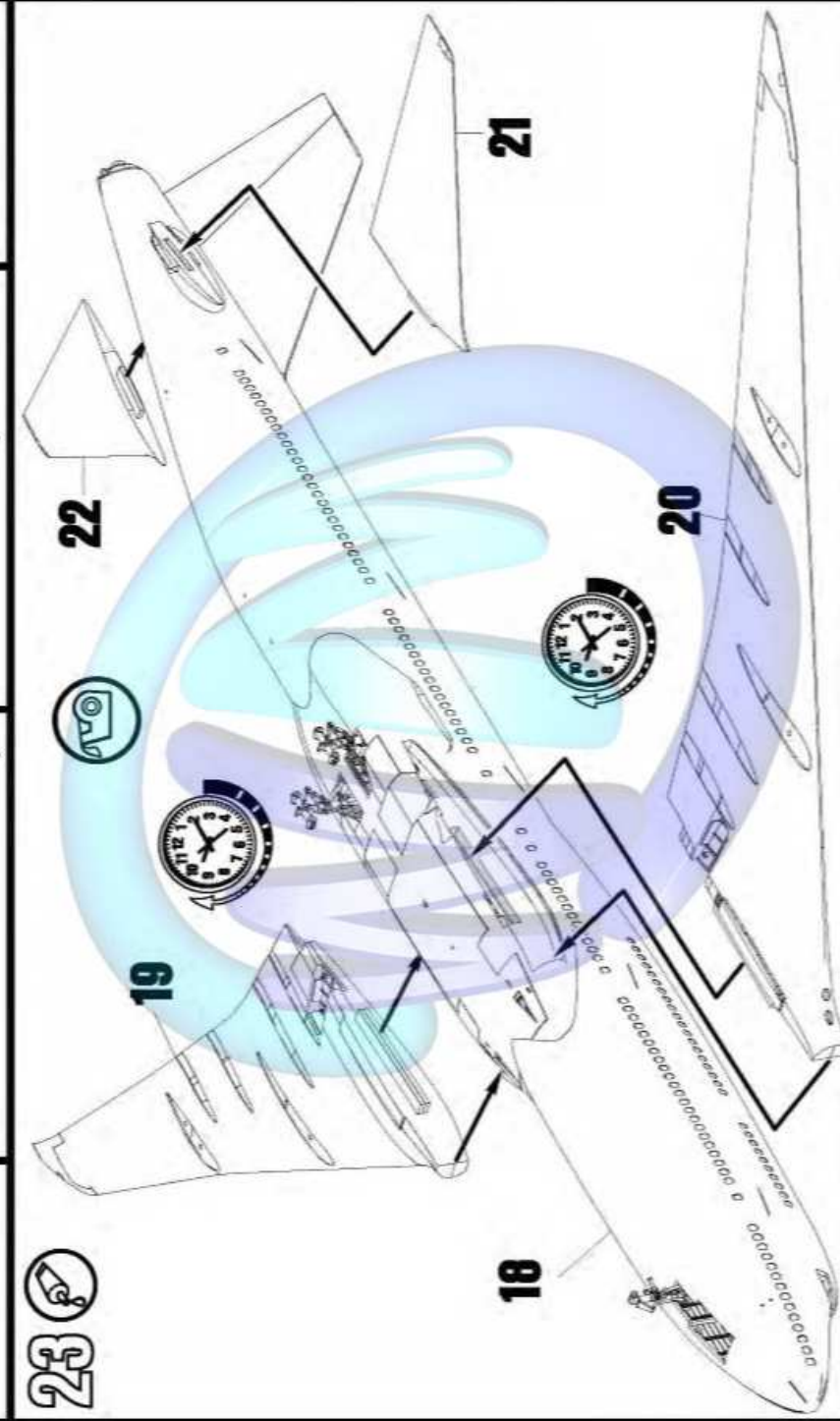
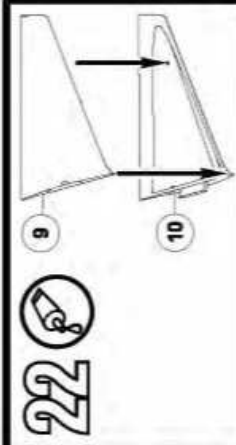
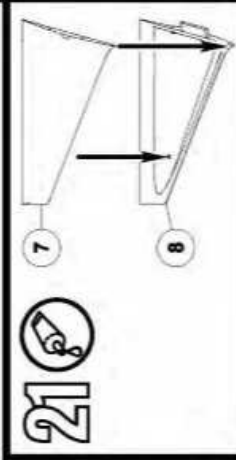
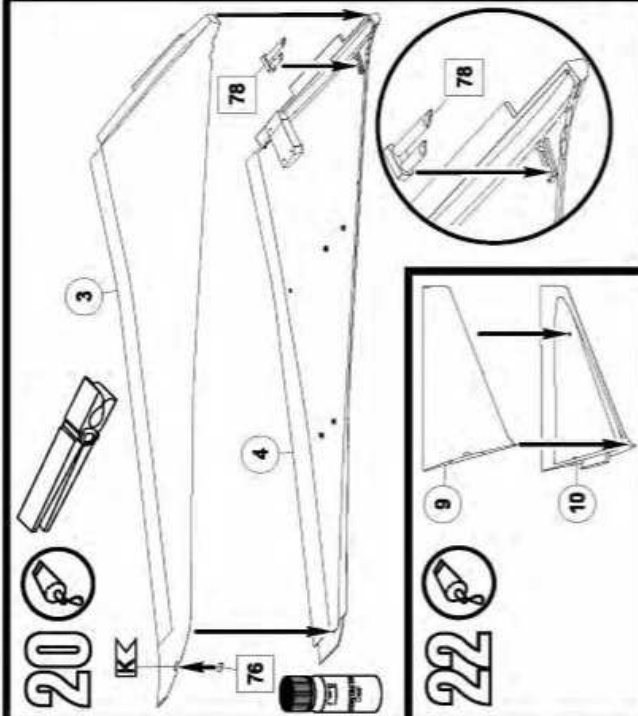
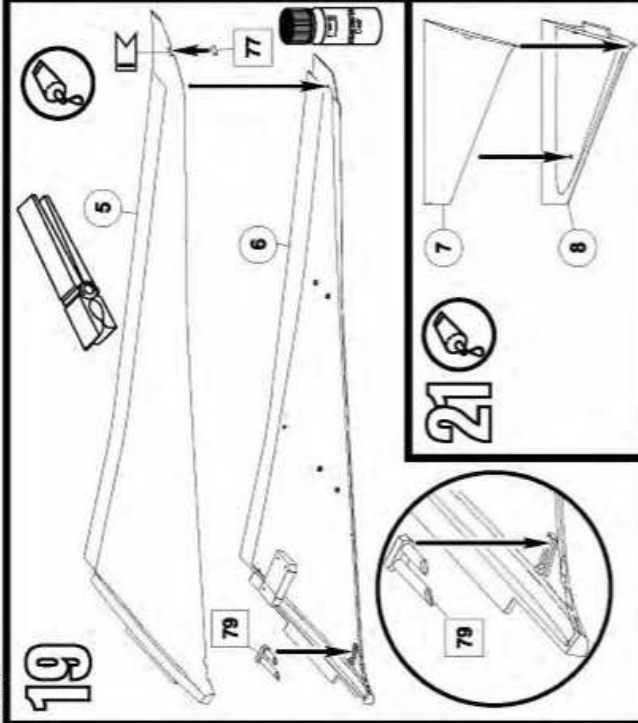

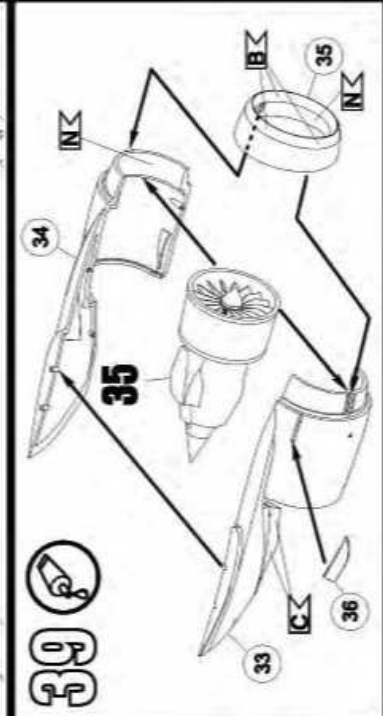
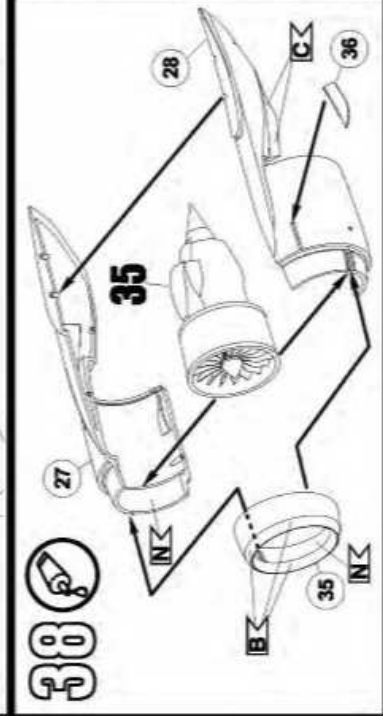
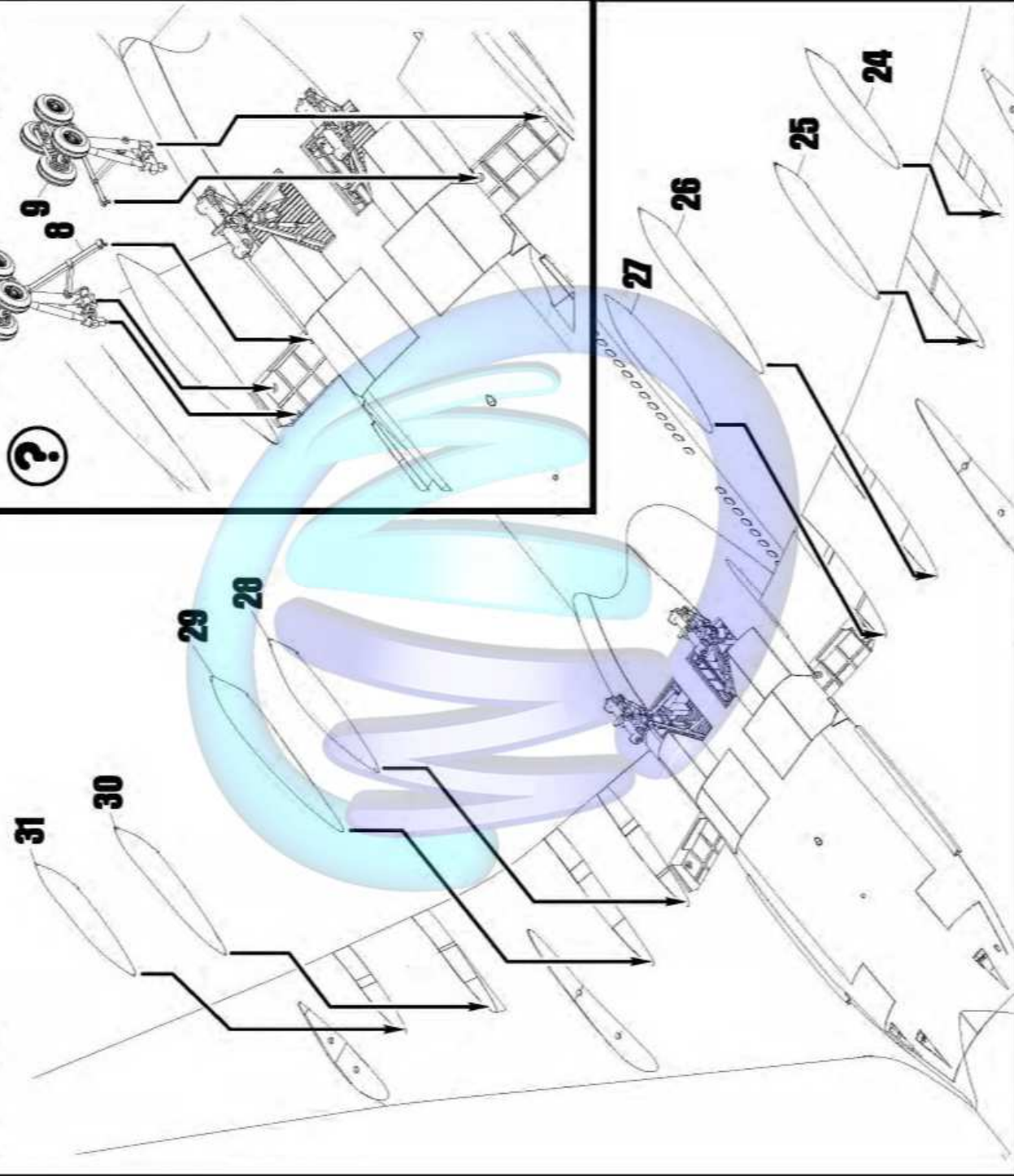
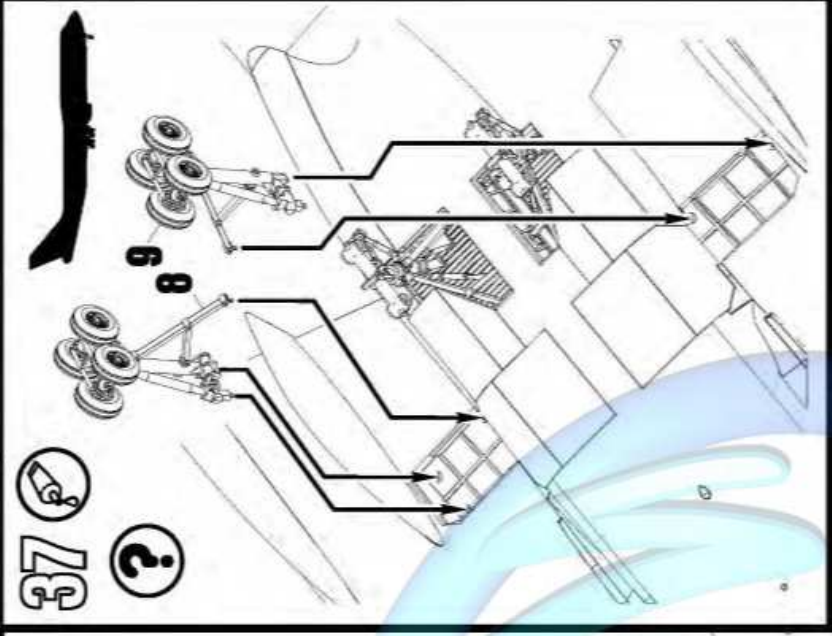
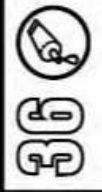
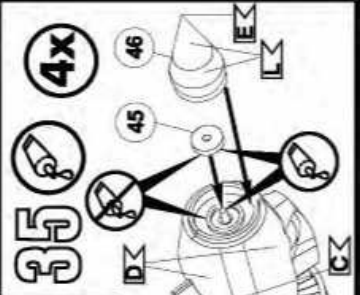
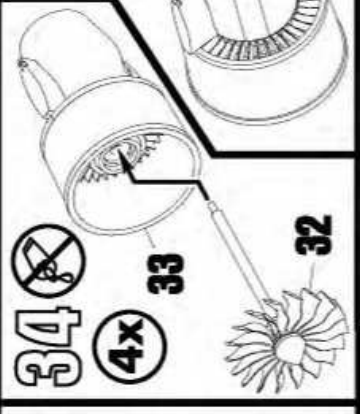
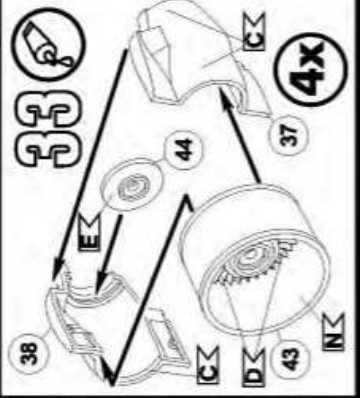
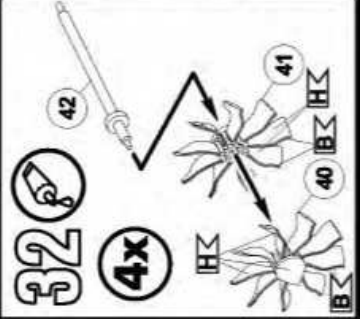

40 

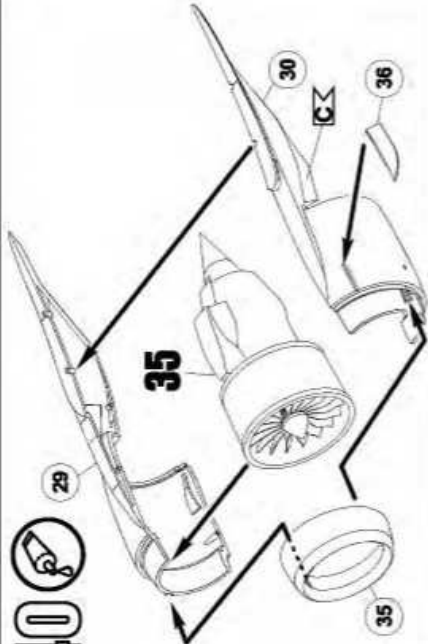

41 

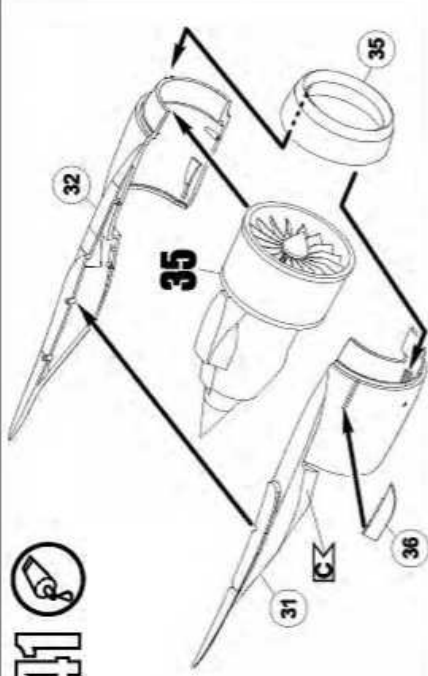

42 

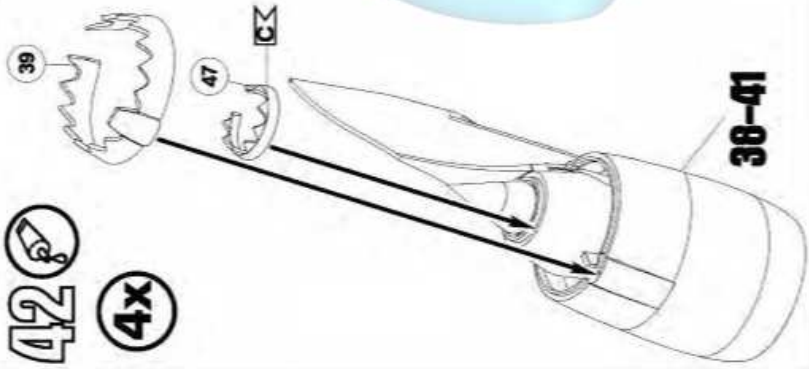

4x

43 

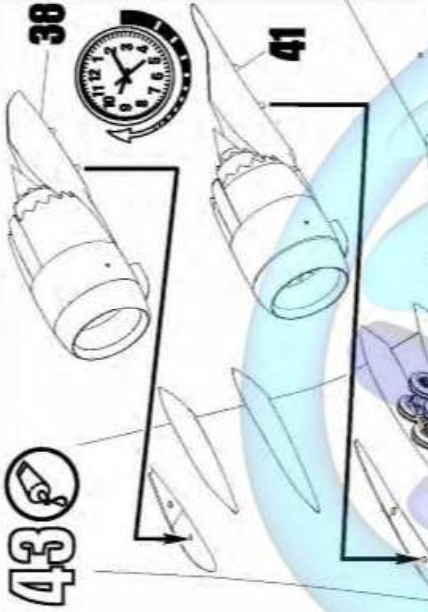

44  ?

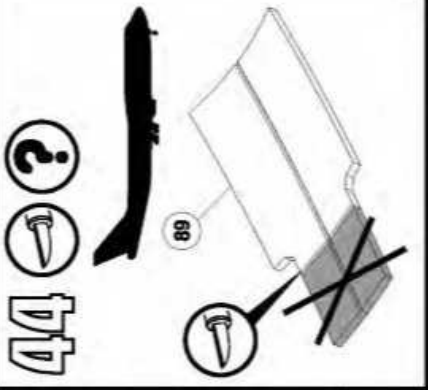

45 

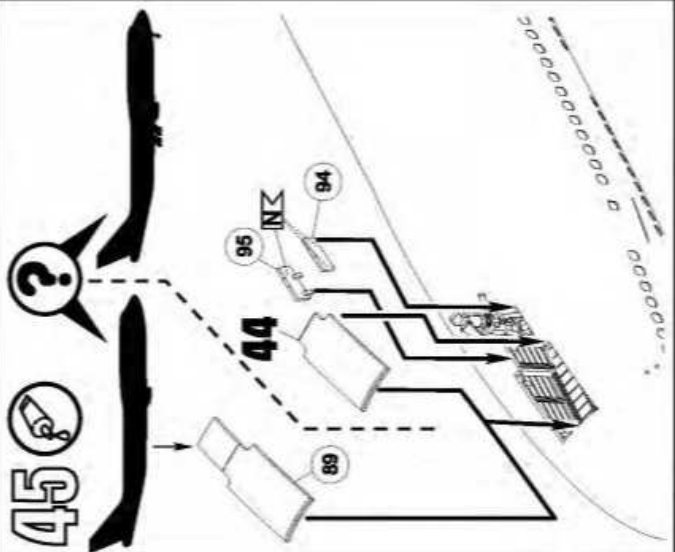

46 

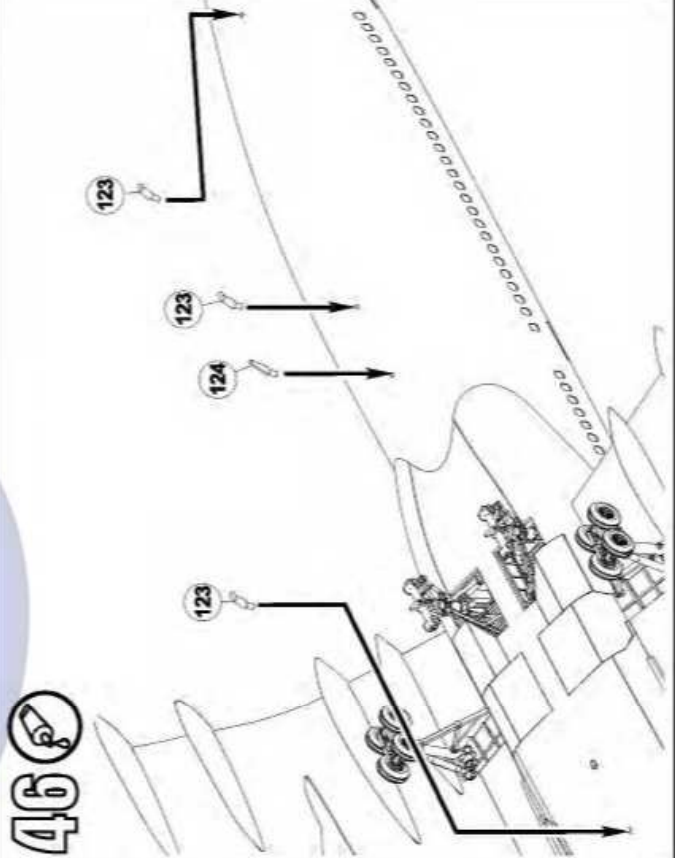

47 ?

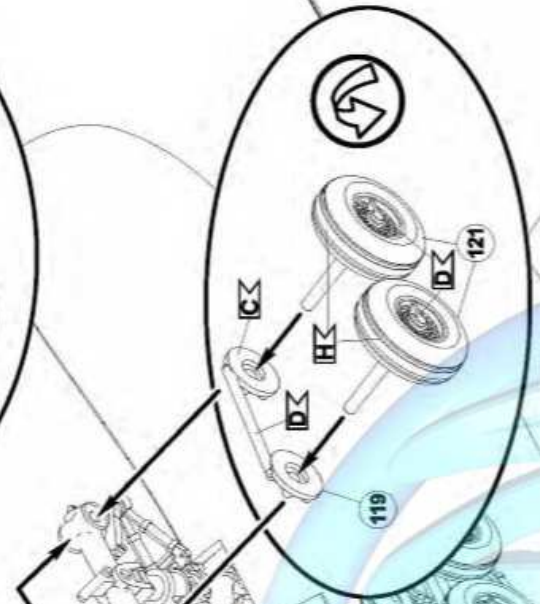
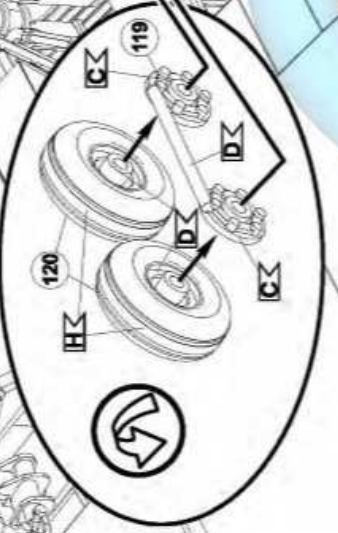
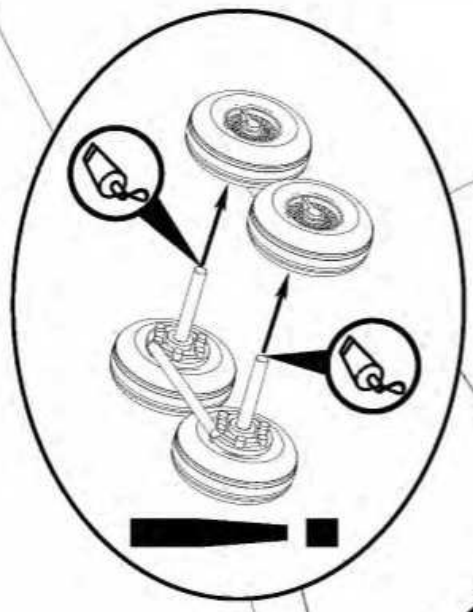

48 ?



49 ?

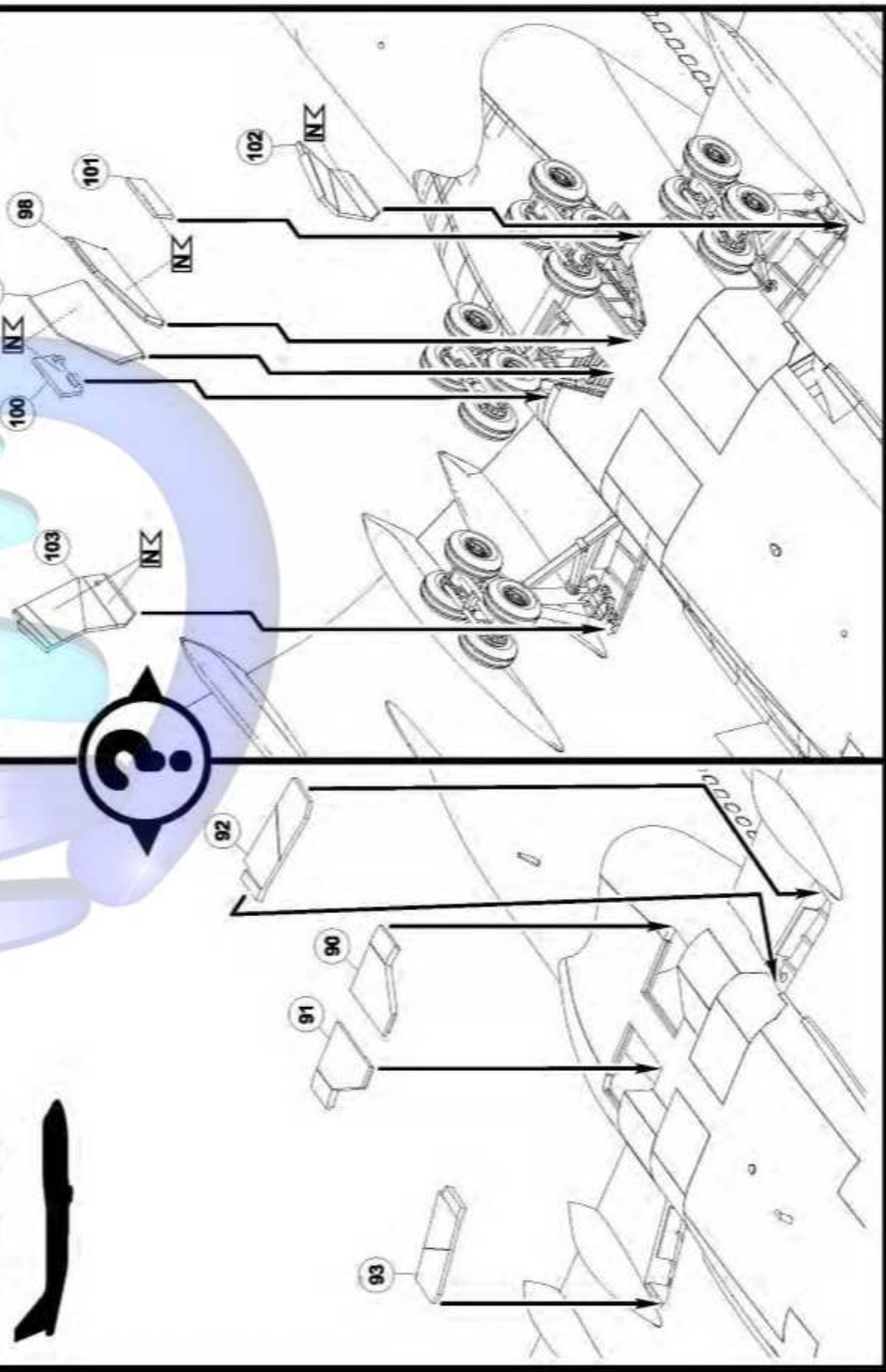

50

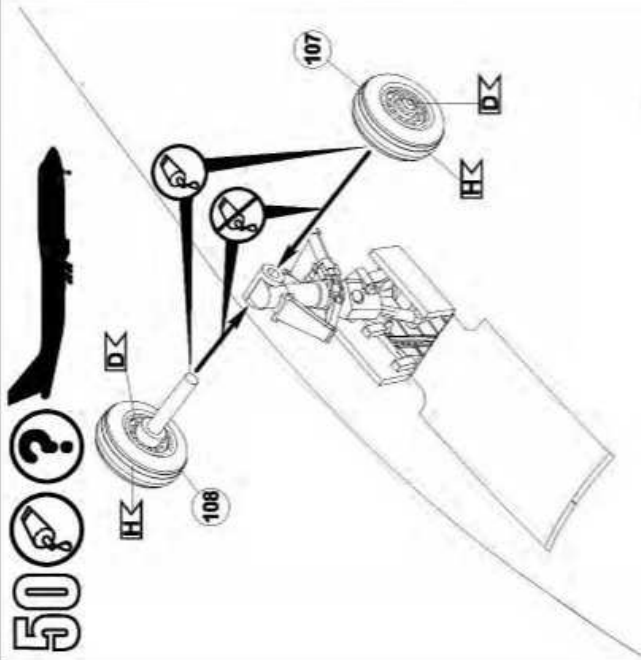

51

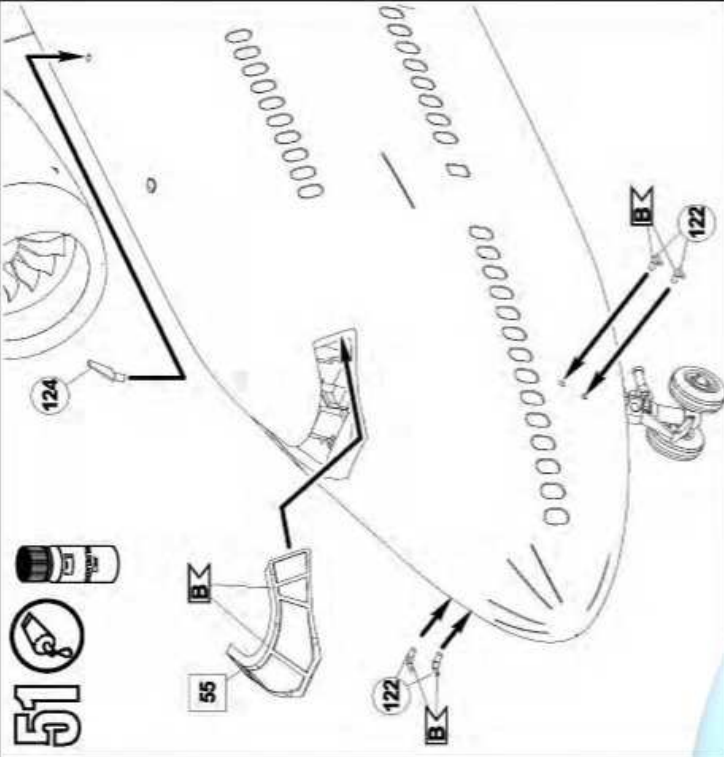

52

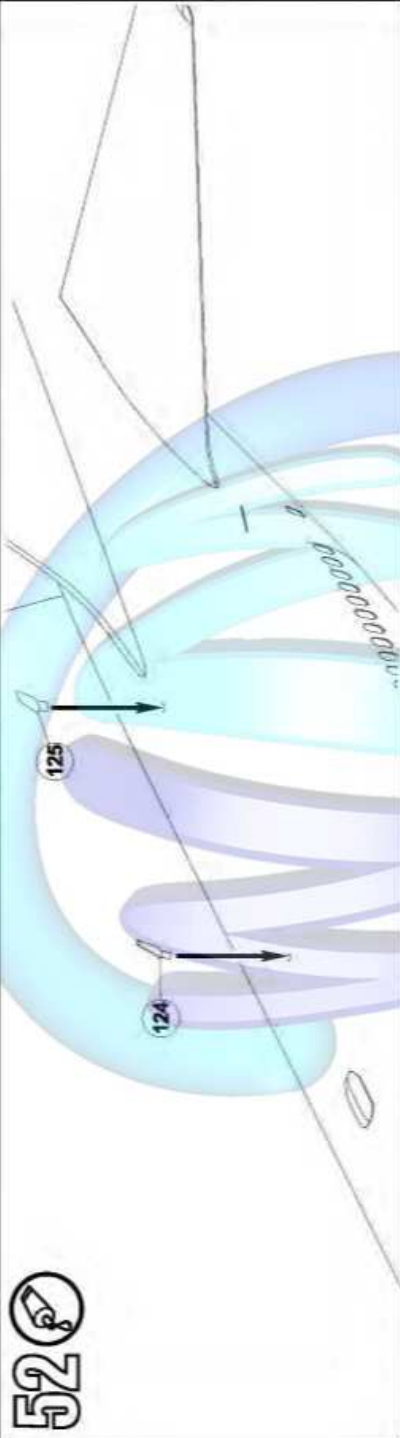

53

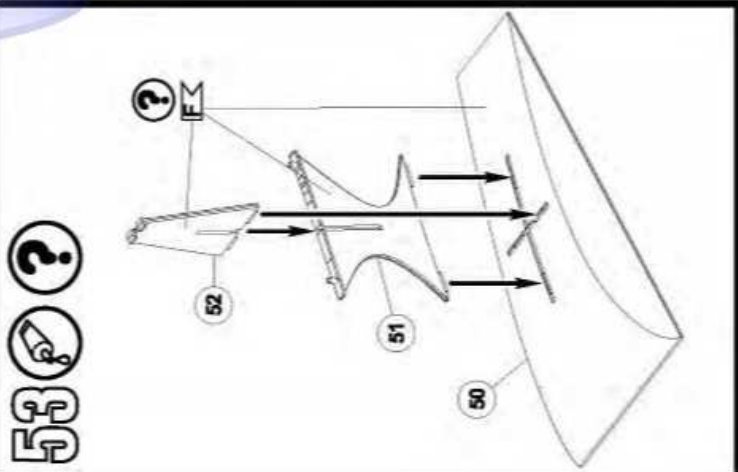

54

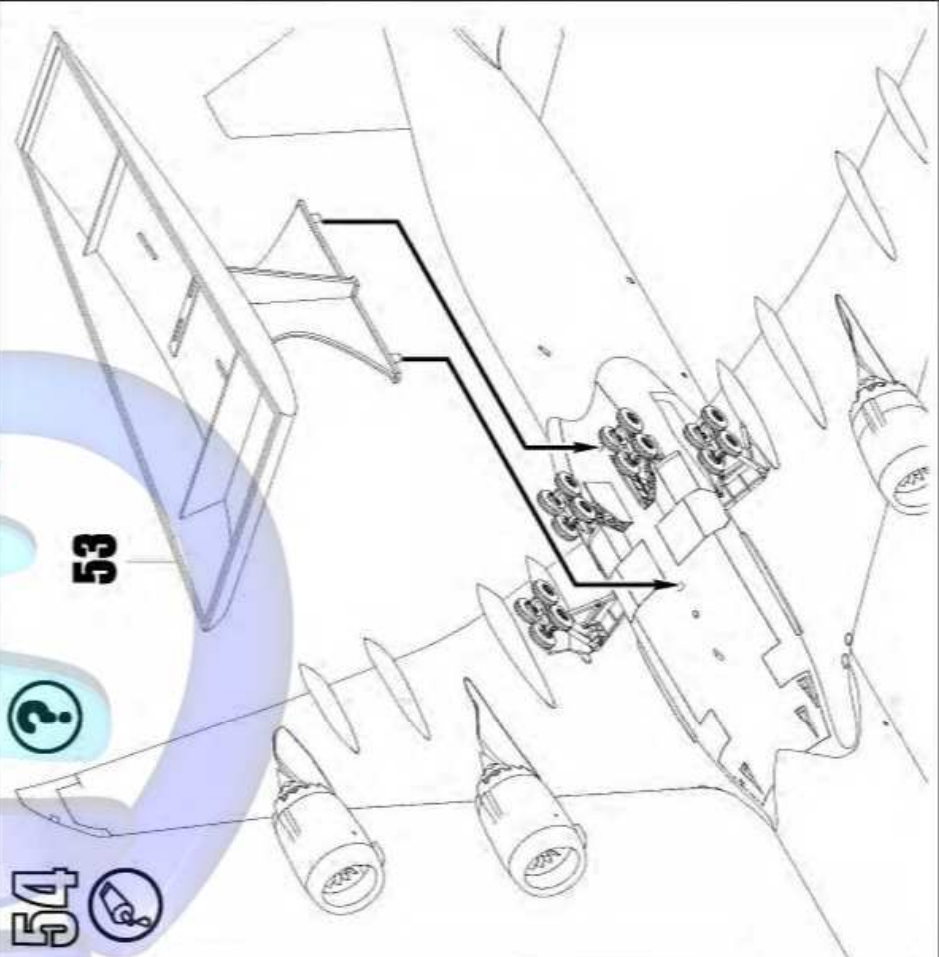



Boeing 747-8™, D-ABYI 'Potsdam' Fanhansa Siegerflieger

Flight LH 2014, Rio de Janeiro - Berlin
14 July 2014

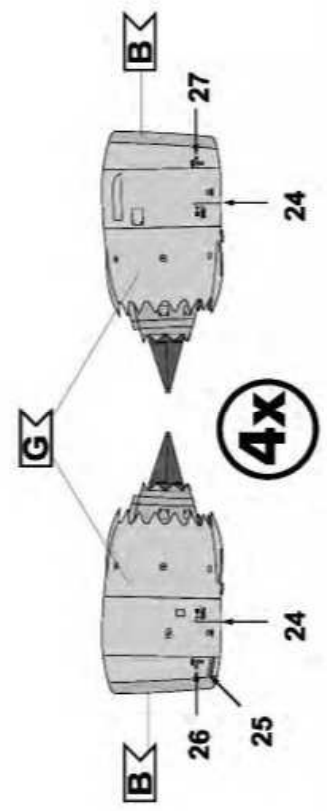
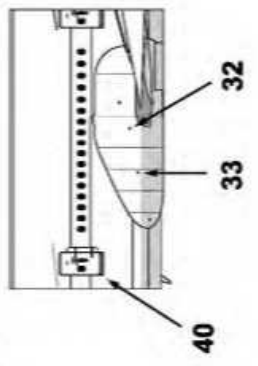
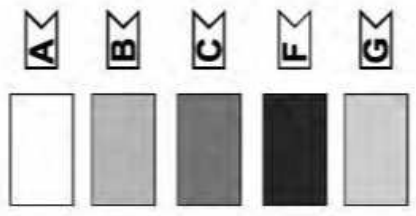
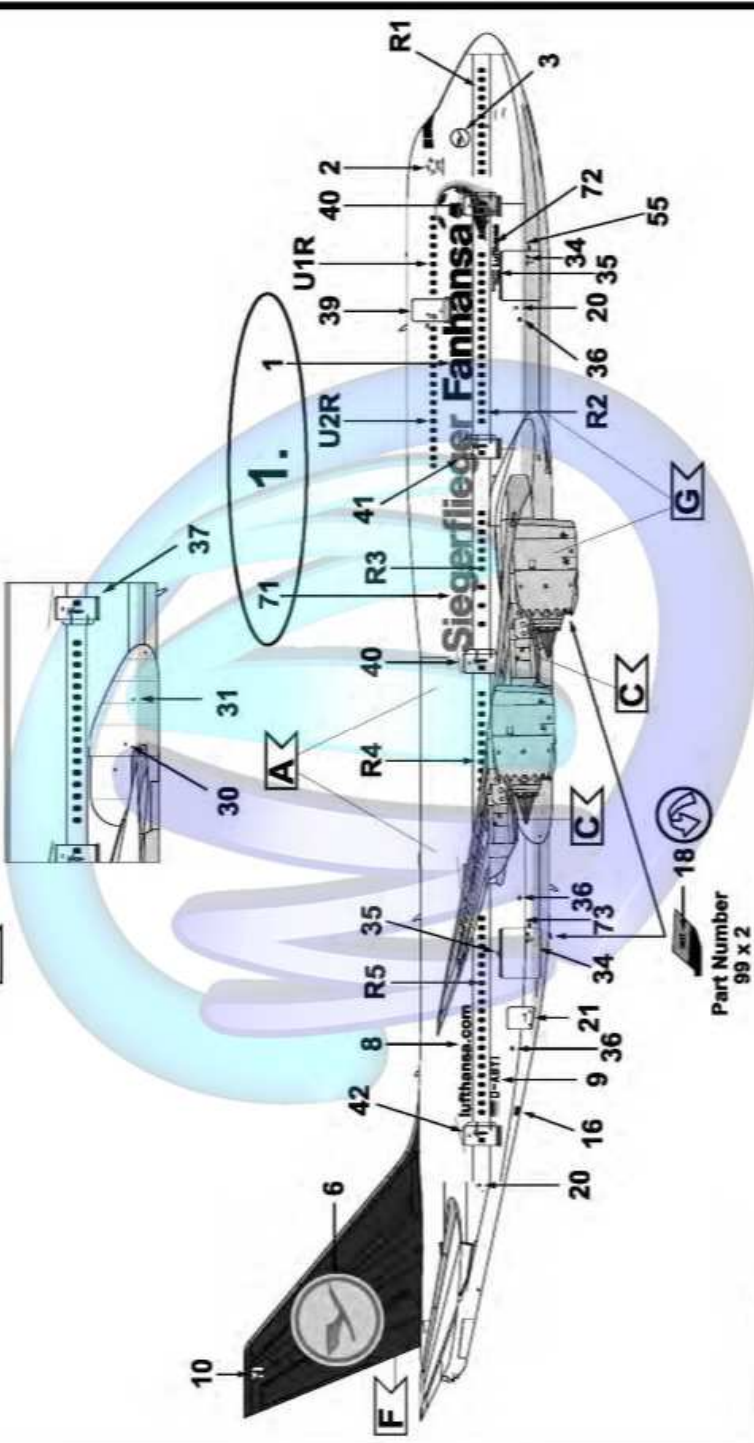
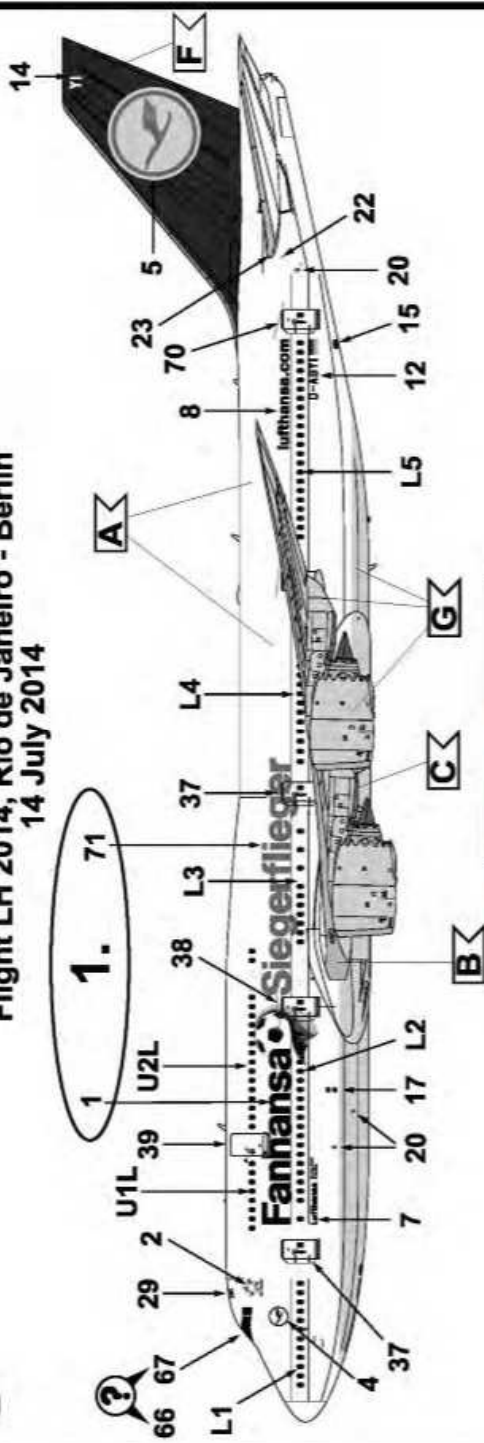

Part Number
99 x 2

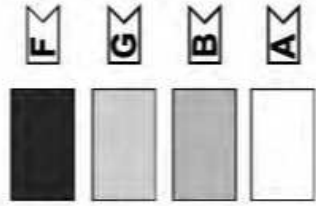
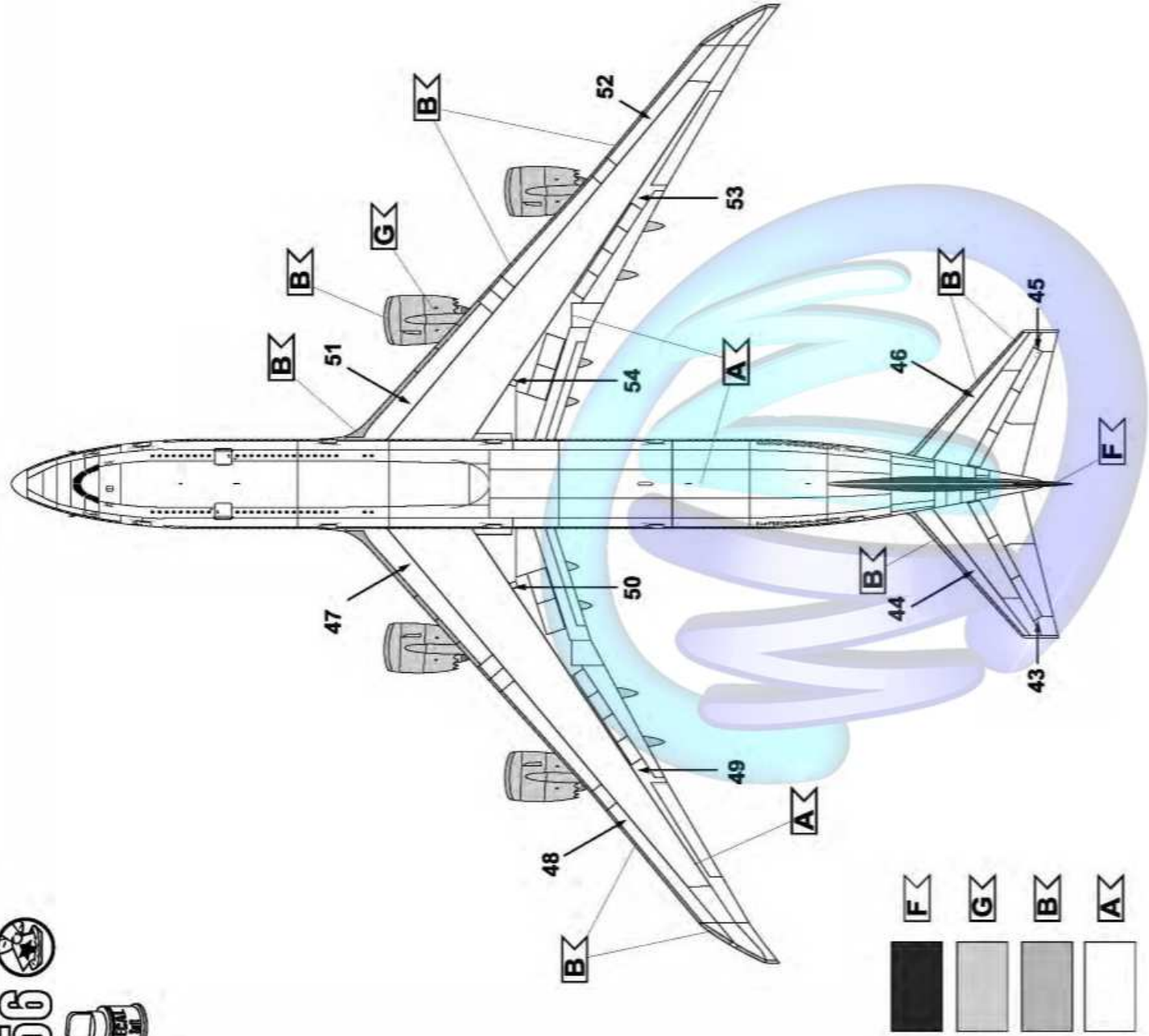



57

